

10. Wet Detention Basin

Description
 A wet detention basin is a stormwater management facility that includes a permanent pool of water for removing pollutants and additional capacity above the permanent pool for detaining stormwater runoff.

<u>Regulatory Credits</u>	<u>Feasibility Considerations</u>
<p><i>Pollutant Removal</i></p> <ul style="list-style-type: none"> 85% Total Suspended Solids 30% Total Nitrogen 40% Total Phosphorus <p><i>Water Quantity</i></p> <ul style="list-style-type: none"> yes Peak Runoff Attenuation no Runoff Volume Reduction 	<ul style="list-style-type: none"> Med-Large Land Requirement Med Cost of Construction Med Maintenance Burden Med-Large Treatable Drainage Basin Size Med Possible Site Constraints Med Community Acceptance

<u>Advantages</u>	<u>Disadvantages</u>
<ul style="list-style-type: none"> - Can be aesthetically pleasing and can be sited in both low- and high-visibility areas. - Can provide wildlife habitat and a focal point for recreation. - Provides good water quantity control for reducing the frequency of flooding events that cause bank erosion. 	<ul style="list-style-type: none"> - Sometimes create problems such as nuisance odors, algae blooms, and rotting debris when not properly maintained. - Local regulations may impose unappealing features such as fencing around basins to reduce safety hazards. - May attract excessive waterfowl, which can be a nuisance and can increase fecal coliform levels. - May contribute to thermal pollution so may not be appropriate in areas where sensitive aquatic species live.

Major Design Elements*

<p>Required by the NC Administrative Rules of the Environmental Management Commission. Other specifications may be necessary to meet the stated pollutant removal requirements.</p>	
1	Sizing shall take into account all runoff at ultimate build-out, including off-site drainage.
2	Vegetated slopes shall be no steeper than 3:1.
3	BMP shall be located in a recorded drainage easement with a recorded access easement to a public ROW.
4	Basin discharge shall be evenly distributed across a minimum 30 feet long vegetative filter strip unless it is designed to remove 90% TSS. (A 50-ft filter is required in some locations.)
5	If any portion is used for S&EC during construction must be cleaned out and returned to design state.
6	The design storage shall be above the permanent pool.
7	Discharge rate of the treatment volume shall completely draw down between 2 and 5 days.
8	The average depth of the permanent pool shall be a minimum of 3 feet. The average depth shall be calculated as described in Figure 10-2b.
9	Permanent pool surface area shall be determined using Tables 10-1, 10-2, 10-3, and 10-4.
10	The flow within the pond shall not short-circuit the pond.
11	BMP shall be designed with a forebay.
12	Basin side slopes shall be stabilized with vegetation above the permanent pool level.
13	The pond shall be designed with side slopes below the 10ft shelf stabilized per what the soils will support and per the PE's judgment.
14	The basin shall be designed with sufficient sediment storage to allow for proper operation between scheduled cleanouts.
<p>Required by DWQ policy. These are based on available research, and represent what DWQ considers necessary to achieve the stated removal efficiencies.</p>	
15	BMP shall not be located to produce adverse impacts on water levels in adjacent wetlands.
16	A minimum 10-foot wide vegetated shelf shall be installed around the perimeter. The inside edge of the shelf shall be 6" below the permanent pool elevation; the outside edge of the shelf shall be 6" above the permanent pool elevation.
17	The forebay volume should be about 20% of the total permanent pool volume, leaving about 80% of the design volume in the main pool.
18	Freeboard shall be a minimum of 1 foot above the maximum stage of the basin.
19	The permanent pool elevation shall be within 6 inches (plus or minus) of the SHWT elevation.

*For multiple pond permits, please specify the areas of the site (including the lot numbers) draining to each pond.

10.1. General Characteristics and Purpose

In wet detention basins, a permanent pool of standing water is maintained by the riser—the elevated outlet of the wet detention basin (see Figure 10-1). Water in the permanent pool mixes with and dilutes the initial runoff from storm events. Wet detention basins fill with stormwater and release most of the mixed flow over a period of a few days, slowly returning the basin to its normal depth.

Runoff generated during the early phases of a storm usually has the highest concentrations of sediment and dissolved pollutants. Because a wet detention basin dilutes and settles pollutants in the initial runoff, the concentration of pollutants in the runoff released downstream is reduced. Following storm events, pollutants are removed from water retained in the wet detention basin. Two mechanisms that remove pollutants in wet detention basins include settling of suspended particulates and biological uptake, or consumption of pollutants by plants, algae, and bacteria in the water. However, if the basin is not adequately maintained (e.g., by periodic excavation of the captured sediment), storm flows may re-suspend sediments and deliver them to the stream.

Figure 10-1
Permanent Pool of Water in Wet Detention Basin



Wet detention basins are applicable in residential, industrial, and commercial developments where enough space is available. Figures 10-2a and 10-2b are schematic plan views showing the basic elements of a wet detention basin. Wet detention basins are sized and configured to provide significant removal of pollutants from the incoming stormwater runoff. The permanent pool of water is designed for a target TSS removal efficiency according to the size and imperviousness of the contributing watershed. Above this permanent pool of water, wet detention basins are also designed to hold the runoff volume required by the stormwater regulations, and to release it over a period of 2 to 5 days. As a result, most of the suspended sediment and pollutants attached to the sediment settle out of the water. In addition, water is slowly released so that downstream erosion from smaller storms is lessened.

Figure 10-2a
Basic Wet Detention Basin Elements: Plan View

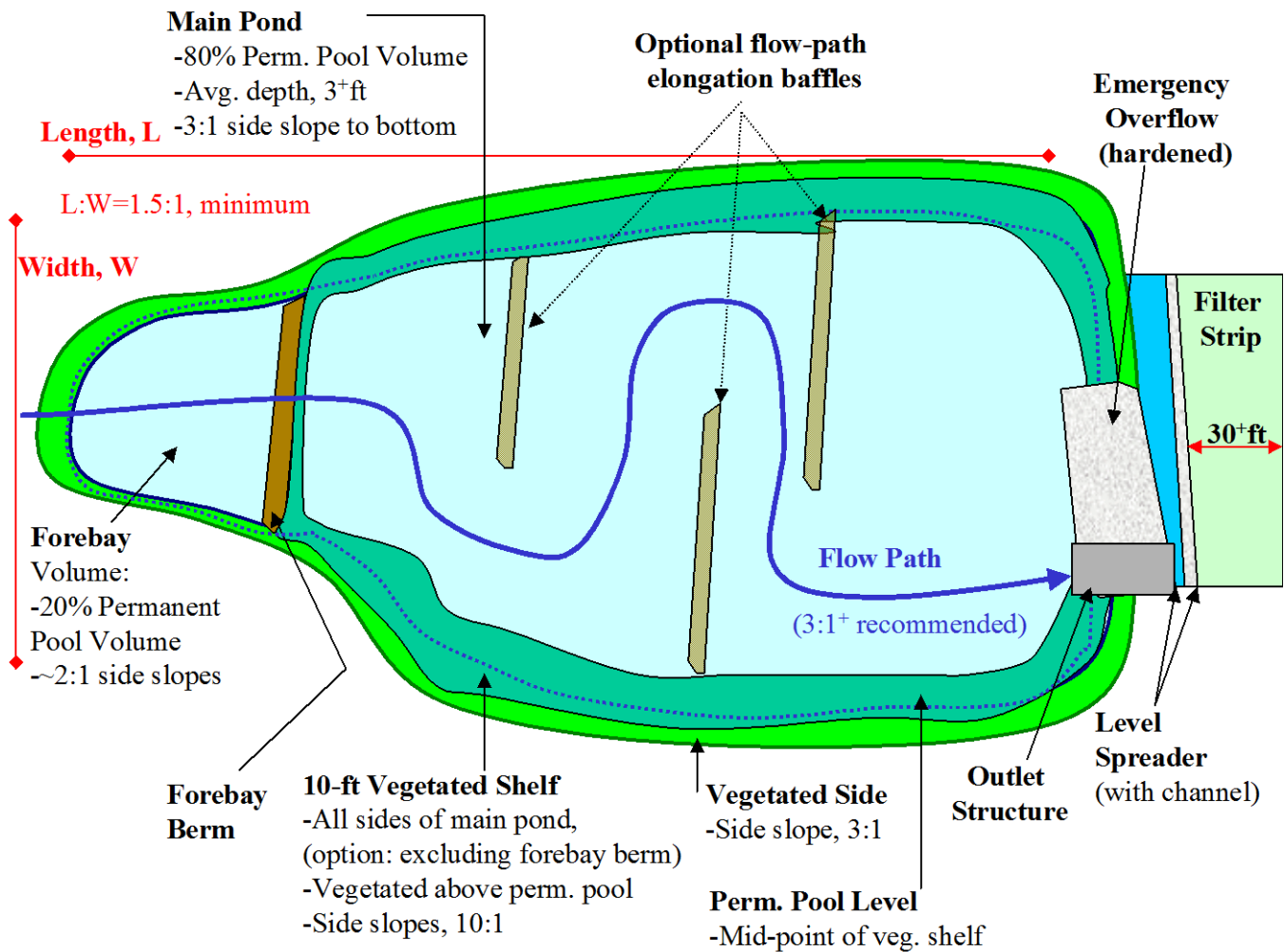
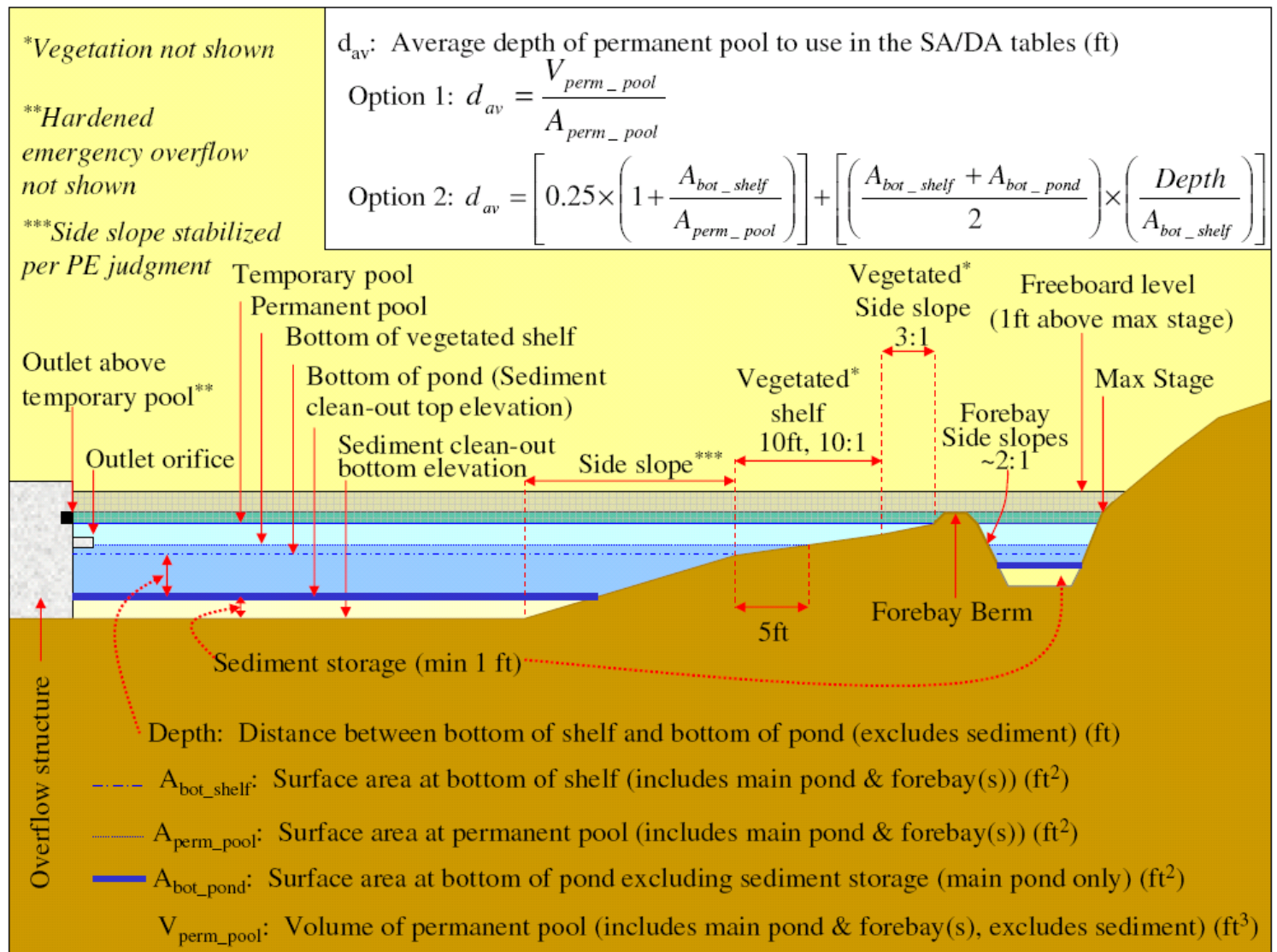

Figure 10-2b

Basic Wet Detention Basin Elements: Cross-Section



10.2. Meeting Regulatory Requirements

North Carolina rules require that a wet detention basin must be designed by a licensed professional. Further, the designer must subsequently certify that he inspected the facility during construction, that the BMP was built in accordance with the approved plans, and that the system complies with the requirements of the rules.

To obtain a permit to construct a wet detention basin in North Carolina, the wet detention basin must meet all of the regulation-based Major Design Elements listed in the beginning of this section.

To receive the pollutant removal rates listed in the front of this section, the wet detention basin engineering design must, at a minimum, meet all of the Major Design Elements listed in the beginning of this section. Additional regulation-based requirements, and additional good engineering practice requirements, may be required by DWQ.

10.2.1 Pollutant Removal Rates

Standard pollutant rates are provided in Table 4-2 in Section 4.0. Construction of a wet detention basin also passively lowers nutrient loading since it is counted as pervious surface when calculating nutrient loading. Further enhancing the passive reduction of nutrient loading is the fact that the surface area of any permanent water surface contributes no nutrient runoff (an export coefficient of 0.0 lb/ac/yr).

10.2.2 Volume Control Calculations

Calculations for the temporary pool volume draw-down time are provided in Section 3.4.

If this BMP comes close to meeting your regulatory requirements, but is not exactly what is desired for your site, then these similar types of BMPs might be worth considering: stormwater wetlands, dry extended detention basins.

If this BMP will not meet the regulatory requirements of the site by itself, but is desired to be part of the stormwater treatment solution for the site for other reasons, the following stormwater controls can be used in conjunction to provide enhanced pollution removal rates or volume control capabilities: sand filters, bioretention, infiltration devices, porous pavement, filter strips, grassed swales, and restored riparian buffers.

10.2.3 Irrigating from Wet Ponds

Permittees often want to irrigate from ponds, particularly during times of drought. This raises questions about the viability of the plants on the vegetated littoral shelf. In times of drought, the plants on the littoral shelf are already stressed, but evidence has shown that they do recover once the drought ends. The minimum 3ft average depth is required by 15A NCAC 02H .1008(e)(3), and is also controlled by outside factors such as the seasonable high water table (SHWT). Ponds that are built with permanent pools well above the SHWT will tend to dry out faster during a drought.

During drought or an extended dry spell, water in a wet pond may be pumped out and used for irrigation with the following provisions:

1. Are DWQ Permits Needed? We do not see any requirement in the Environmental Management Commission (EMC) rules that would dictate that a discharge (NPDES), state stormwater or nondischarge permit be required for anyone withdrawing water from a stormwater BMP, such as a wet detention pond. There are several potential problems that may require future action by the Environmental Management Commission but, at this time, our rules and policies do not prohibit this practice.
2. Any Special Plumbing Requirements? Since the water is not associated with a building, the NC Building Code plumbing requirements would not apply. However, it is recommended that lines be clearly marked to prevent any cross connection with potable water or accidental use for drinking.
3. Any Potential Health Issues? We would recommend caution in using the water in an above ground spray system. A special risk occurs when algae growth and the associated cyanobacteria produce toxins that could be released in an aerosol form. In Florida, we've seen at least one documented case where irrigation spray from an algae-laden pond caused several citizens to become ill. There is at least one district of the state where they only allow use of pond water for irrigation if it is drawn from an adjacent shallow water well to provide some filtration of pollutants. Although there does not seem to be evidence of such adverse effects occurring in North Carolina, a property owner should be cognizant of the potential liability from such a situation. Of course, improperly treated stormwater can contain other types of harmful bacteria that, when placed in human skin contact, could be a health issue.
4. Adverse Affects on Plants: There has been some concern about the adverse impact on littoral plants in a stormwater pond if the water level was kept low for long periods of time. There are varying opinions on what period of drawdown time would result in plant mortality. Some citizens have commented that the aesthetic issues of a drawn-down pond would help keep this problem in check. Nonetheless, if a pond's plants were to die, the required inspections should note that a violation of the O&M conditions of the permitting agreement had occurred and would need to be corrected.
5. Erosion Issues: As with all irrigation, caution should be taken to make sure that spray does not occur on lands that would result in surface runoff to streams or erosion on bare areas.
6. Drawdown Issues: From a water quality standpoint, greater detention capacity in a stormwater pond system because of drawdown should be a plus. However, drawdown should not eliminate the permanent pool since the settling accomplished in the pool is a vital mechanism for pollutant removal. Irrigation cannot be used as the sole means of drawing down the temporary pool volume.

10.3. Design

10.3.1. Converting Sediment and Erosion Control Devices

Wet detention basins are typically part of the initial site clearing and grading activities and are often used as sediment basins during construction of the upstream development. The NCDENR *Erosion and Sediment Control Planning and Design Manual* contains design requirements for sediment basins required during construction. A sediment basin typically does not include all the engineering features of a wet detention basin, and the design engineer must insure that the wet detention basin includes all the features identified in this section, including the full sizing as a wet detention basin. If the wet detention basin is used as a sediment trap during construction, all sediment deposited during construction must be removed, erosion features must be repaired, and the vegetated shelf must be restored, before operation as a stormwater BMP begins.

10.3.2. Siting Issues

Because large storage volumes are needed to achieve extended detention times, wet detention basins require larger land areas than many other BMPs. Wet detention basins may not be suitable for projects with very limited available land. Permanent retaining walls may be used to obtain the required design volumes while reducing the footprint that would otherwise be required for earthen construction. Retaining walls utilized to contain the permanent pool must not reduce the required 10' width of the vegetated shelf, and must not extend to a top elevation above the lowest point of the vegetated shelf. Retaining walls utilized to contain the temporary pool must not reduce the required 10' width of the vegetated shelf, and must not be in contact with the stormwater stored up to the temporary pool elevation. Two retaining walls may be used, as shown in Figure 10-3a. Or, the design may be altered to contain only one of the two shown.

Figure 10-3a
Alternative Wet Pond Design: Retaining Wall Option

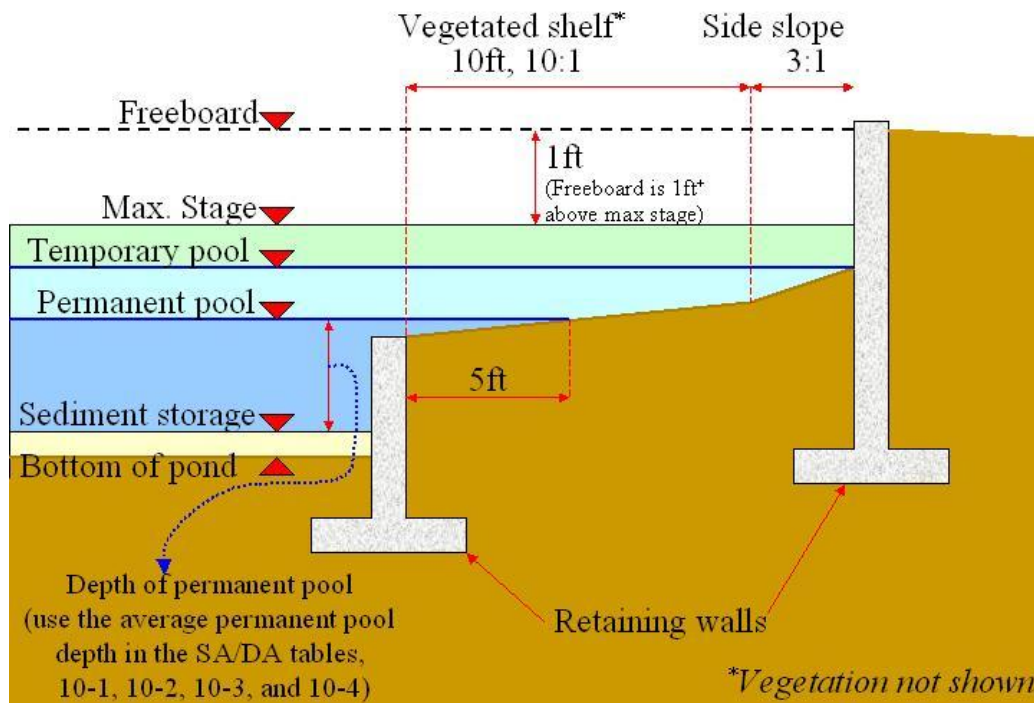

Wet detention basins may not be constructed on intermittent streams, on perennial streams, or in jurisdictional wetlands. Large wet detention basins that include a wetland fringe and are abandoned in place without first being drained and regraded may be regulated as wetlands under the provisions of Sections 401 and 404 of the Clean Water Act.

DWQ requires a soils report that includes a determination of the SHWT elevation for all wet pond designs. The permanent pool elevation shall meet the following requirements:

1. The PPE must be no more than six inches above or below the SHWT.
2. If the design proposed does not meet the requirement of item 1 above, then the following must be provided:
 - a. A calculation-based hydrogeological analysis of the proposed wet pond and surrounding subsurface conditions must demonstrate it will not adversely affect wetlands, surface waters, and buffers.
 - b. The analysis must demonstrate that the permanent pool will remain at the proposed PPE to insure the survival of the plants on the vegetated shelf.
 - c. Demonstrate that the downstream conveyances, including ditches and pipes from the pond to the named receiving waters, will be able to function adequately and maintain a free flow condition such that the treatment volume is released in 2-5 days under SHWT conditions.

- d. Evaluate the orifice size to effectively deal with the incoming groundwater such that the water level is maintained at the design PPE and such that the design storm volume is allowed to exit the pond in 2-5 days.

It is recognized as good engineering practice that the proposed PPE be at approximately the same elevation as the SHWT. The Division has established an acceptable range of SHWT elevation. This range will ensure that the pond does not adversely affect wetlands, surface waters, and buffers; and holds water as designed. Additionally, it provides some allowance for the potential inaccuracy of the exact SHWT elevation.

If site conditions do not allow the PPE to be designed within the preferred range for the SHWT elevation, then (1) an analysis of the proposed wet pond design must demonstrate it will not adversely affect wetlands, surface waters, and buffers; and holds water as designed. One acceptable analysis includes using the Dupuit equation that models steady unconfined flow between two canals or reservoirs. It is the responsibility of the designer to satisfy DWQ that the proposed design will not adversely affect wetlands. 15A NCAC 02B .0231 requires that DWQ protect wetlands from being dewatered, filled, etc.; and (2) Demonstrate that the downstream conveyances, including ditches and pipes from the pond to the named receiving waters, will be able to function adequately and maintain a free flow condition such that the treatment volume is released in 2-5 days under SHWT conditions; and (3) Evaluate the orifice size to effectively deal with the incoming groundwater such that the water level is maintained at the design PPE and such that the design storm volume is allowed to exit the pond in 2-5 days.

For circumstances where a calculation-based hydrogeological analysis shows that the proposed PPE will affect wetlands, surface waters, or groundwater elevations in buffers, DWQ may accept engineering measures to eliminate those affects. The same calculation-based analysis requirement applies for the proposed engineering measures.

If a hydrogeological analysis is required, either because the PPE is outside of the preferred range, or because DWQ otherwise requests an analysis, DWQ expects that a sufficient analysis will have the following minimum elements: (1) multiple soil samples serving to identify the soil type, (2) multiple field K results, (3) multiple soil samples to establish the SHWT at the proposed pond location, (4) a clear statement of the conservative aspects of the design case subjected to the hydrogeological analysis, and (5) a listing of the limiting assumptions and a citation from the literature attesting to the applicability of the design equations or analytical method applied. DWQ recognizes that groundwater flow can be approximated through various equations and methods, and we look to the design professional to apply the appropriate method for their specific site.

Figure 10-3b

Seasonal High Water Table and Permanent Pool Level

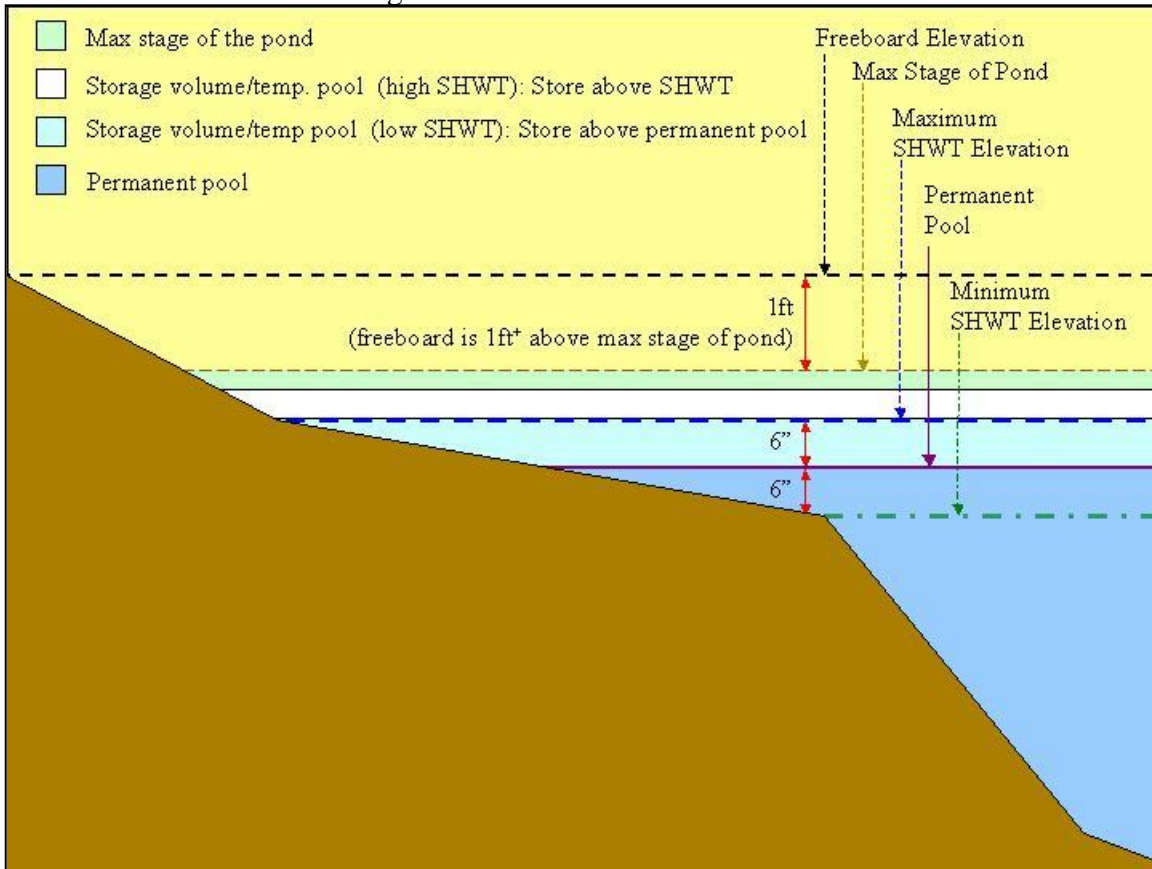

The use of stormwater wet detention basins discharging to cold-water streams capable of supporting trout may be prohibited. Stormwater wet detention basins located in such watersheds should be augmented with engineering measures to significantly reduce or eliminate thermal impacts.

10.3.3. Pretreatment and Inflow

Forebays are required on all inlets to a wet detention basin. Chapter 5 Common BMP Design Elements addresses the engineering design requirements for forebays and the forebay berms. A properly engineered forebay can concentrate large particle-size sediment for easier removal, and can dissipate the incoming flow energy prior to the stormwater entering the main part of the BMP. The dissipation of incoming flow energy reduces re-suspension of settled material in the main pool, and it reduces the likelihood of erosion features within the BMP. Also, the forebay itself should be configured for energy dissipation within the forebay to avoid re-suspension of large-particle settled material previously captured in the forebay. One of several engineering means of energy dissipation is to have the inlet pipe submerged below the permanent forebay pool level, provided that the inlet placement does not serve to re-suspend previously captured sediment.

DWQ requires that the design volume for the forebay be approximately 20% of the total calculated permanent pool volume. The main pool of the permanent pool would then account for approximately 80% of the design volume. If the pond has more than one forebay, the total volume of the forebays should equal 20% of the permanent pool volume. In this case, each forebay should be sized as in Figure 10-3c.

Figure 10-3c
Forebay Sizing

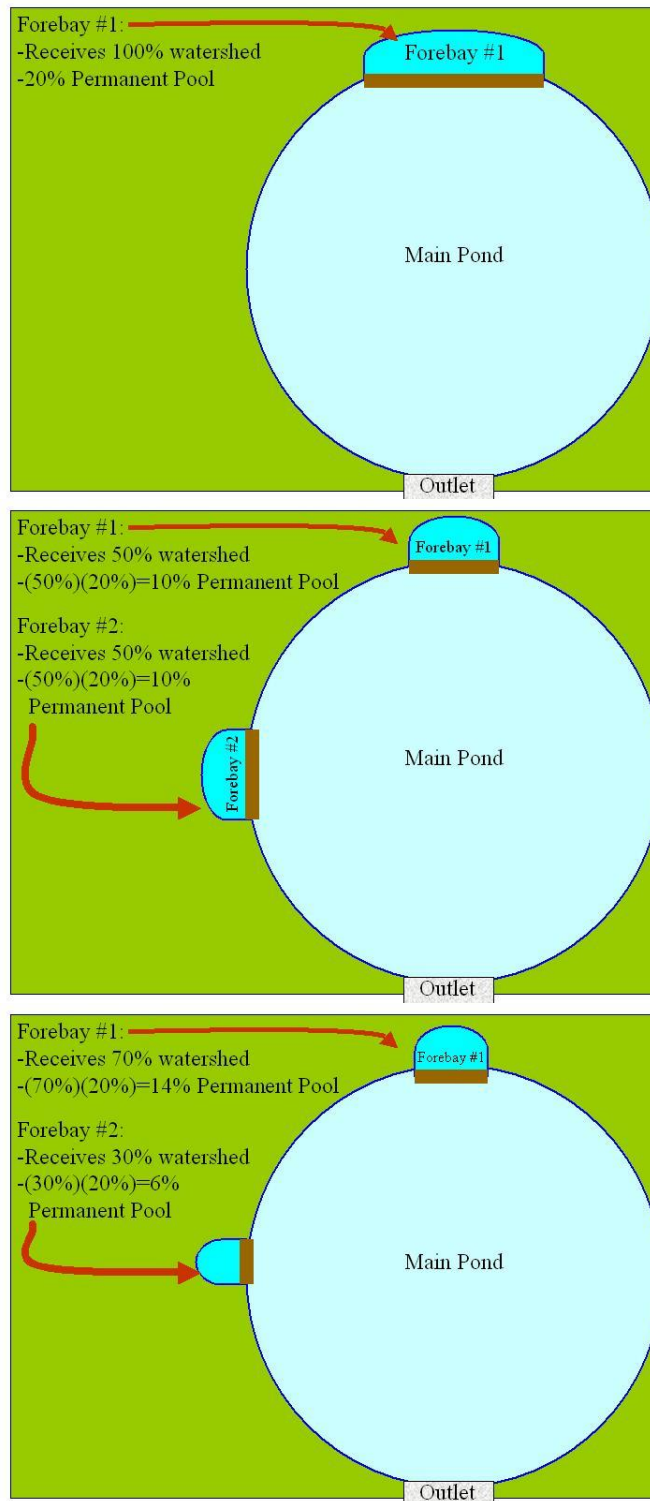

10.3.4. Length, Width (Area), Depth, Geometry

DWQ uses Driscoll’s model (US EPA, 1986) to determine the appropriate surface area of the permanent pool for wet detention basins to achieve the required TSS removal rate. The surface area required can be determined using the permanent pool Surface Area to Drainage Area ratio (SA/DA) for given levels of impervious cover and basin depths as outlined in Tables 10-1, 10-2, 10-3, and 10-4. **The tabulated SA/DA ratios are reported as percentages.** Table 10-1 is based upon 85 percent TSS removal efficiency in the Mountain and Piedmont regions of North Carolina, while Table 10-2 is based upon 85 percent removal efficiencies for the Coastal region. Table 10-3 presents the design SA/DA ratio for 90 percent TSS removal efficiencies in the Mountain and Piedmont regions, and Table 10-4 presents a similar table for the Coast.

Depth is an important engineering design criterion because most of the pollutants are removed through settling. Very shallow basins may develop currents that can re-suspend materials; on the other hand, very deep wet detention basins can become thermally stratified and/or anoxic and release pollutants back into the water. North Carolina regulations establish 3 feet as the minimum average depth. An average pool depth of 3 feet to 7.5 feet is recommended as optimal. Further, DWQ requires that the engineering design include a minimum freeboard of one foot above the maximum stage of the basin. Freeboard should be designed as shown in Figures 10-2b, 10-3a, 10-3b and 10-3c. Also, DWQ requires that the engineering design incorporate a minimum additional depth of one foot for sediment storage.

The Division has received stormwater applications for the use of existing mining pits or other non-regulated existing natural or man-made water bodies for stormwater treatment. Many times, these waters are deeper than the SA/DA tables allow. Having a deep pond raises concerns about thermal inversion. Pond depths up to 20 feet will not affect the function of the pond and thermal inversion will not create enough upward velocity to adversely affect water quality. Pond depths up to 20’ may be permitted in existing non-regulated water bodies. Construction of new ponds that exceed the 7.5’ average depth can also be considered. However, since the SA/DA tables only go up to 7.5’, use the 7.5’ average depth SA/DA ratio to determine the minimum required surface area.

Permanent pool average depth can be calculated in two ways:

- Option 1: Permanent pool volume divided by the permanent pool surface area.
- Option 2: Use the following equation (Also see Figure 10-2b)

$$d_{av} = \left[0.25 \times \left(1 + \frac{A_{bot_shelf}}{A_{perm_pool}} \right) \right] + \left[\left(\frac{A_{bot_shelf} + A_{bot_pond}}{2} \right) \times \left(\frac{Depth}{A_{bot_shelf}} \right) \right]$$

Where:

- d_{av} = Average permanent pool depth (ft)
- A_{bot_shelf} = Surface area at bottom of shelf, including forebay (ft²)

- A_{perm_pool} =Surface area at permanent pool level, including forebay (ft²)
- A_{bot_pond} =Surface area at the bottom of the pond (ft²) (excludes the sediment cleanout depth)
- $Depth$ = Distance between the bottom of the shelf and the pond bottom (ft) (excludes the sediment cleanout depth)

Example:

- Surface area at permanent pool: 10,000 ft², including forebay
- Surface area at bottom of shelf: 8,000 ft², including forebay
- Surface area at bottom of pond: 2,000 ft²
- Depth: 4.5 ft

Average Depth, $d_{av} = .25 \times (1 + (8000/10,000)) + ((8000 + 2000)/2) \times 4.5 / 8000 = 3.26$ ft

Therefore use 3.0 to enter the SA/DA table. (To avoid multiple interpolations, please round the average depth down to the nearest 0.5'.)

Table 10-1

Surface Area to Drainage Area Ratio for Permanent Pool Sizing to Achieve 85 Percent TSS Pollutant Removal Efficiency in the Mountain and Piedmont Regions, Adapted from Driscoll, 1986

Percent Impervious Cover	Permanent Pool Average Depth (ft)						
	3.0	4.0	5.0	6.0	7.0	8.0	9.0
10%	0.59	0.49	0.43	0.35	0.31	0.29	0.26
20%	0.97	0.79	0.70	0.59	0.51	0.46	0.44
30%	1.34	1.08	0.97	0.83	0.70	0.64	0.62
40%	1.73	1.43	1.25	1.05	0.90	0.82	0.77
50%	2.06	1.73	1.50	1.30	1.09	1.00	0.92
60%	2.40	2.03	1.71	1.51	1.29	1.18	1.10
70%	2.88	2.40	2.07	1.79	1.54	1.35	1.26
80%	3.36	2.78	2.38	2.10	1.86	1.60	1.42
90%	3.74	3.10	2.66	2.34	2.11	1.83	1.67

Table 10-2

Surface Area to Drainage Area Ratio for Permanent Pool Sizing to Achieve 85 Percent TSS Pollutant Removal Efficiency in the Coastal Region, Adapted from Driscoll, 1986

Percent Impervious Cover	Permanent Pool Average Depth (ft)									
	3.0	3.5	4.0	4.5	5.0	5.5	6.0	6.5	7.0	7.5'
10%	0.9	0.8	0.7	0.6	0.5	0	0	0	0	0
20%	1.7	1.3	1.2	1.1	1.0	0.9	0.8	0.7	0.6	0.5
30%	2.5	2.2	1.9	1.8	1.6	1.5	1.3	1.2	1.0	0.9
40%	3.4	3.0	2.6	2.4	2.1	1.9	1.6	1.4	1.1	1.0
50%	4.2	3.7	3.3	3.0	2.7	2.4	2.1	1.8	1.5	1.3
60%	5.0	4.5	3.8	3.5	3.2	2.9	2.6	2.3	2.0	1.6
70%	6.0	5.2	4.5	4.1	3.7	3.3	2.9	2.5	2.1	1.8
80%	6.8	6.0	5.2	4.7	4.2	3.7	3.2	2.7	2.2	2.0
90%	7.5	6.5	5.8	5.3	4.8	4.3	3.8	3.3	2.8	2.3
100%	8.2	7.4	6.8	6.2	5.6	5.0	4.4	3.8	3.2	2.6

Table 10-3

Surface Area to Drainage Area Ratio for Permanent Pool Sizing to Achieve 90 Percent TSS Pollutant Removal Efficiency in the *Mountain and Piedmont* Regions, Adapted from Driscoll, 1986

Percent Impervious Cover	Permanent Pool Average Depth (ft)												
	3.0	3.5	4.0	4.5	5.0	5.5	6.0	6.5	7.0	7.5	8.0	8.5	9.0
10%	0.9	0.8	0.8	0.7	0.6	0.6	0.5	0.5	0.5	0.5	0.4	0.4	0.4
20%	1.5	1.3	1.1	1.0	1.0	0.9	0.9	0.9	0.8	0.8	0.8	0.7	0.7
30%	1.9	1.8	1.7	1.5	1.4	1.4	1.3	1.1	1.0	1.0	1.0	0.9	0.9
40%	2.5	2.3	2.0	1.9	1.8	1.7	1.6	1.6	1.5	1.4	1.3	1.2	1.1
50%	3.0	2.8	2.5	2.3	2.0	1.9	1.9	1.8	1.7	1.6	1.6	1.5	1.5
60%	3.5	3.2	2.8	2.7	2.5	2.4	2.2	2.1	1.9	1.9	1.8	1.8	1.7
70%	4.0	3.7	3.3	3.1	2.8	2.7	2.5	2.4	2.2	2.1	2.0	2.0	1.9
80%	4.5	4.1	3.8	3.5	3.3	3.0	2.8	2.7	2.6	2.4	2.3	2.1	2.0
90%	5.0	4.5	4.0	3.8	3.5	3.3	3.0	2.9	2.8	2.7	2.6	2.5	2.4

Table 10-4

Surface Area to Drainage Area Ratio for Permanent Pool Sizing to Achieve 90 Percent TSS Pollutant Removal Efficiency in the *Coastal Region*, Adapted from Driscoll, 1986

Percent Impervious Cover	Permanent Pool Average Depth (ft)									
	3.0	3.5	4.0	4.5	5.0	5.5	6.0	6.5	7.0	7.5'
10%	1.3	1.0	0.8	0.7	0.6	0.5	0.4	0.3	0.2	0.1
20%	2.4	2.0	1.8	1.7	1.5	1.4	1.2	1.0	0.9	0.6
30%	3.5	3.0	2.7	2.5	2.2	1.9	1.6	1.3	1.1	0.8
40%	4.5	4.0	3.5	3.1	2.8	2.5	2.1	1.8	1.4	1.1
50%	5.6	5.0	4.3	3.9	3.5	3.1	2.7	2.3	1.9	1.5
60%	7.0	6.0	5.3	4.8	4.3	3.9	3.4	2.9	2.4	1.9
70%	8.1	7.0	6.0	5.5	5.0	4.5	3.9	3.4	2.9	2.3
80%	9.4	8.0	7.0	6.4	5.7	5.2	4.6	4.0	3.4	2.8
90%	10.7	9.0	7.9	7.2	6.5	5.9	5.2	4.6	3.9	3.3
100%	12	10.0	8.8	8.1	7.3	6.6	5.8	5.1	4.3	3.6

The engineering design of a wet detention basin must include a 10-foot-wide (minimum) vegetated shelf around the full perimeter of the basin. The inside edge of the shelf shall be no deeper than 6" below the permanent pool level, and the outside edge shall be 6" above the permanent pool level. For a 10' wide shelf, the resulting slope is 10:1. With half the required shelf below the water (maximum depth of 6 inches), and half the required shelf above the water, the vegetated shelf will provide a location for a diverse population of emergent wetland vegetation that enhances biological pollutant removal, provides a habitat for wildlife, protects the shoreline from erosion, and improves sediment trap efficiency. A 10' wide shelf also provides a safety feature prior to the deeper permanent pool.

Short-circuiting of the stormwater must be prevented. The most direct way of minimizing short-circuiting is to maximize the length of the flow path between the inlet and the outlet: basins with long and narrow shapes can maximize the length of the flow path. Long and narrow but irregularly shaped wet detention basins may appear more

natural and therefore may have increased aesthetic value. If local site conditions prohibit a relatively long, narrow facility, baffles may be placed in the wet detention basin to lengthen the stormwater flow path as much as possible. Baffles must extend to the temporary pool elevation or higher. A minimum length-to-width ratio of 1.5:1 is required, but a flow path of at least 3:1 is recommended. Basin shape should minimize dead storage areas, and where possible the width should expand as it approaches the outlet.

Although larger wet detention basins typically remove more pollutants, a threshold size seems to exist above which further improvement of water quality by sedimentation is negligible. The permanent pool volume within a wet detention basin is calculated as the total volume beneath the permanent pool water level, and above the sediment storage volume, including any such volume within the forebay.

10.3.5. Temporary Storage Volume

In addition to the permanent pool volume, the basin must also have temporary pool storage to provide volume control during storm events. This temporary pool storage volume is located above the permanent pool, and below the 1-foot minimum freeboard requirement. The required temporary pool volume must be calculated as specified in Section 3.3.1.

10.3.6. Sediment Accumulation

North Carolina rules require that the wet detention basin shall be sized with an additional volume to account for sediment deposition between clean-out intervals (typically 5 to 15 years). DWQ requires that engineering designs for wet detention basins include at least one additional foot of depth for sediment storage in addition to the permanent pool volume. This additional one foot of depth shall be provided in both the main pond area and in the forebay. It is important that operation and maintenance agreements specify that the forebay and the wet pond be cleaned out as soon as the extra sediment storage depth is exhausted. A benchmark for sediment removal should be established to assure timely maintenance. Calculations for volumes and sediment accumulation are provided in Section 3.0.

10.3.7. Plant and Landscape Requirements

The design of a wet detention basin is not complete without a detailed landscaping plan. The planting plan must be prepared by a qualified design professional licensed in North Carolina (see Chapter 6 for landscape plan requirements). The landscaping plan for a stormwater wet detention basin should provide specifications for the selection of vegetation, its installation, and the post-installation care for the vegetated shelf, the 3:1 side slopes, the vegetative filter strip, and the immediately surrounding areas. **Do not plant weeping love grass on the vegetated side slopes** because it does not provide long-term slope stabilization. Also, trees and woody shrubs should not be planted on the shelf or pond embankments. A wetland seed mix for the shelf is not acceptable.

Wet detention basins should incorporate several (minimum of three (3)) diverse species of shallow water emergent and shallow land herbaceous vegetation on the vegetated shelf. A minimum of 50 plants per 200 sf of shelf area shall be planted. Chapter 9 contains a list of appropriate plant species for the vegetated shelf. Diversity in species increases the robustness of the vegetated shelf by increasing the chances that some species will survive minor changes in the permanent pool water level. This vegetation enhances pollutant removal, protects the shoreline from erosion, and increases safety by discouraging people from entering the basin. A wide range of potential plant species is available for this purpose. Planting density is dependant on the targeted time to full coverage, and on the individual selected species' mature size. One general rule of thumb that may be used is the spacing should be approximately 24" to 36" centers; yielding coverage in approximately 1 - 2 years respectively.

On the tops of berms and on the exterior slopes of containment berms, maintain turf grass in access areas; *Centipede* grass is recommended. Well-maintained grass stabilizes the embankment, enhances access to the facility, and makes inspection and other maintenance much easier. Because many plants release phosphorus in the winter when they die off, wet detention ponds used for phosphorous control should be planted with broad-leaf evergreen trees and shrubs.

Where trees and shrubs are part of the planting plan, they should be outside of the pond and selected to maximize shading, primarily along the south, east, and west sides of the basin. This has two benefits: it reduces thermal heating of the water, and it helps to maintain a healthy and aesthetic pond by reducing algal blooms and the potential for anaerobic conditions. Trees and woody shrubs should not be planted on embankments since under some circumstances their presence can threaten the structural integrity of the embankment. All trees and shrubs should be set back so that the branches will not extend over the basin.

Wildflowers, native grasses, and ground covers should be selected to minimize mowing; fertilizing will be allowed for initial establishment.

10.3.8. Surrounding Soils and Liners

The permanent pool elevation shall be at approximately the same elevation as the SHWT elevation (See 10.3.2). When a wet detention basin is to be located in highly permeable soils like gravelly sands or fractured bedrock, or when the permanent pool elevation proposed is greater than six (6) inches above the SHWT, the designer may need to incorporate a liner to sustain a permanent pool of water. A liner shall be constructed or compacted such that the infiltration rate is no more than 0.01 in/hr. When wet detention basins are near wetlands or other waters, additional engineering calculations and engineering measures may be necessary to insure that these waters will not be adversely affected by the location of the wet detention basin nor will the wet detention basin be drained into the adjacent waters. The installation of additional engineering features, such as slurry walls, liners, or other barriers may be required. When a liner is proposed, topsoil for vegetation must be place on top of the liner.

10.3.9. Outlet Design

The outlet device shall be designed to release the temporary pool volume (minimum required treatment volume as calculated by the Simple Method) over a period of 48 to 120 hours (2 to 5 days). Longer detention times typically do not improve settling efficiency significantly, and the temporary pool volume must be available for the next storm. In addition, prolonged periods of inundation can adversely affect the wetland vegetation growing on the vegetated shelf.

In addition to being designed to achieve the 2 to 5-day drawdown period, outlets also must be functionally simple and easy to maintain. One possible configuration option of the outlet piping that simplifies maintenance and reduces the potential for obstruction is the submerged orifice arrangement shown in Figure 10-4.

Figure 10-4

Typical Submerged Orifice Outlet Configuration

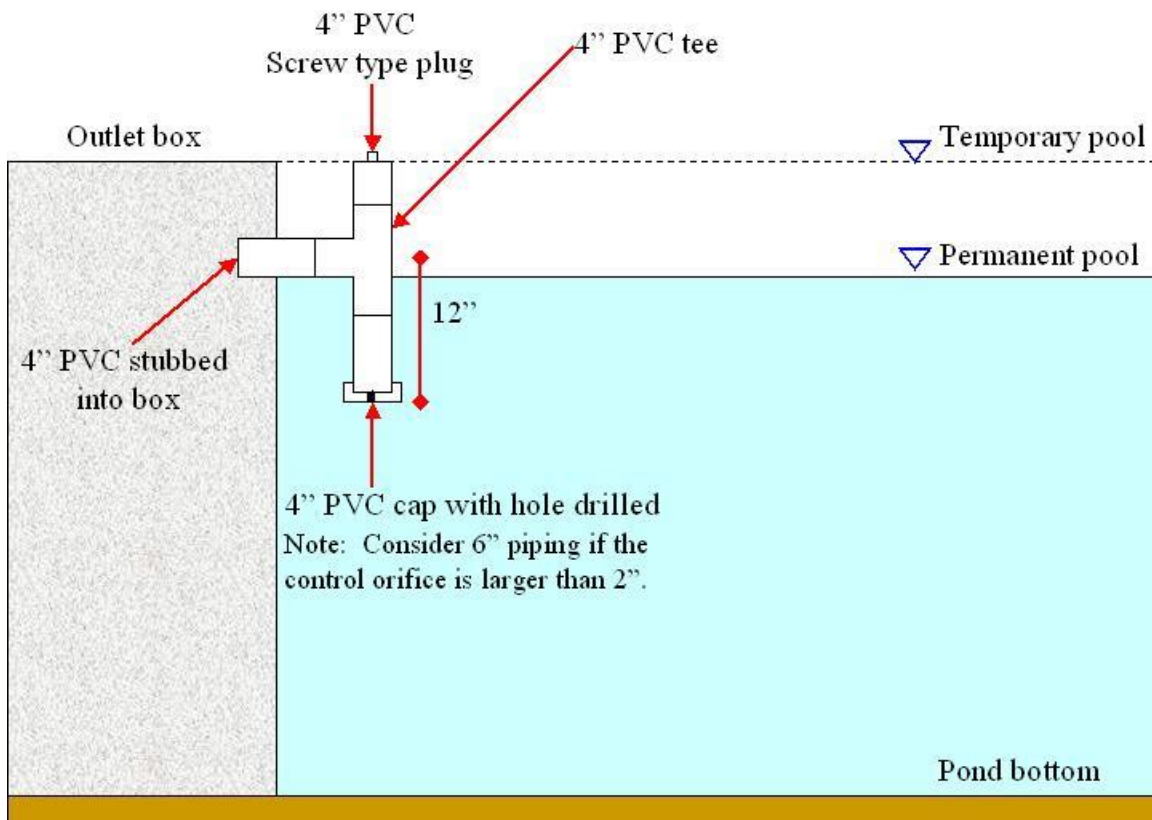

Durable materials, such as reinforced concrete, are preferable to corrugated metal in most instances. The riser should be placed in or at the face of the embankment. By placing the riser close to the embankment, maintenance access is facilitated and flotation forces are reduced. The design engineer must present flotation force calculations for any outlet design subject to flotation forces. Outlets are described in greater detail in Section 5.0, Common BMP Design Elements.

Emergency overflow spillways must be designed with hardened materials at the points where extreme conditions might compromise the integrity of the structure.

Under most circumstances North Carolina rules require a vegetative filter strip on the discharge from a wet detention basin, along with a level spreader or other engineered device to ensure even, non-erosive distribution of the flow. Wet detention ponds designed for 85% TSS removal are required to discharge through a 30 foot vegetated filter to minimize erosion and to provide additional pollutant removal. There may be projects where it is difficult to construct a functional vegetated filter, and the outflow must discharge to the watercourse. In these instances, additional storage should be provided to compensate for the lack of a filter and the pond must be designed to remove 90% TSS instead of 85%. Chapter 13 Filter Strip contains information on the design elements of the vegetative filter strip. Chapter 8 Level Spreader contains information on the design elements of a level spreader.

10.3.10. Fountains in the Wet Pond

Fountains are optional, decorative wet pond amenities. If they are included they shall be designed as follows:

1. Ponds smaller than 30,000ft³ can not have a fountain.
2. The fountain must draw its water from less than 2' below the permanent pool surface.
3. Separated units (where the nozzle, pump and intake are connected by tubing) may be used only if they draw water from the surface in the deepest part of the pond.
4. The falling water from the fountain must be centered in the pond, away from the shoreline.
5. The maximum horsepower for the fountain's pump is based on the permanent pool volume, as described in Table 10-5. As an example, if the pond's volume is 350,000 cubic feet, the maximum pump horsepower for the fountain is 1.

Table 10-5
Fountain Pump Power Requirements

Minimum Pond Volume (ft ³)	Max Pump HP
30,000	1/8
40,000	1/6
60,000	1/4
80,000	1/3
125,000	1/2
175,000	3/4
250,000	1
450,000	2
675,000	3

10.3.11. Safety Considerations

The permanent pool of water presents an attractive play area to children and thus may create safety problems. Engineering design features that discourage child access are recommended. Trash racks and other debris-control structures should be sized to prevent entry by children. Other safety considerations include using fences around the spillway structure, embankment, and wet detention basin slopes; using shallow safety benches around the wet detention basin; and posting warning signs.

Fencing of wet detention basins is not generally aesthetically pleasing but may be required by the local review authority. A preferred method is to engineer the contours of the wet detention basin to eliminate drop offs and other safety hazards as discussed above. Riser openings must not permit unauthorized access. End walls above pipe outfalls greater than 48 inches in diameter should be fenced to prevent falls.

10.4 Construction

Even moderate rainfall events during the construction of a wet detention basin can cause extensive damage to it. Protective measures should be employed both in the contributing drainage area, and at the wet detention basin itself. Temporary drainage or erosion control measures should be used to reduce the potential for damage to the wet detention basin before the site is stabilized. The control measures may include stabilizing the surface with erosion mats, sediment traps, and diversions. Vegetative cover and the emergency spillway also should be completed as quickly as possible during construction.

The designer should address the potential for bedding erosion and catastrophic failure of any buried outlet conduit. A filter diaphragm and drain system should be provided along the barrel of the principal spillway to prevent piping. DWQ is aware of an evolution in standard practice, and of accumulated evidence suggesting that in most circumstances filter diaphragms are much superior to anti-seep collars in preventing piping. DWQ strongly prefers filter diaphragms to the older design anti-seep collar.

If reinforced concrete pipe is used for the principal spillway, "O-ring" gaskets (ASTM C361) should be used to create watertight joints and should be inspected during installation.

10.5. Maintenance

10.5.1 Common Maintenance Issues

Please refer to Section 7.0, General BMP Maintenance, for information on types of maintenance, typical frequency, and specific maintenance tasks that are common to all BMPs. The following information is maintenance that is specific to wet detention basins. Specific items that require careful inspection for a wet detention basin include: evaluation of the aquatic environment, vegetation, and sediment build-up.

A program of monitoring the aquatic environment of a permanent wet detention basin should be established. Items such as water clarity and algal growth should be monitored regularly.

The vegetation located on the vegetated shelf must be properly maintained in order to achieve additional pollutant removal and in order to prevent bank erosion. Bare spots, weeds, and invasive species should be noted and remedied as soon as possible to prevent larger problems. Although a regular grass maintenance program for the upland locations around the BMP will reduce weed intrusion, some weeds invariably will appear. Periodic weeding will therefore be necessary. Chemical application to control weeds should be carefully considered and monitored. Frequent maintenance activities such as removing debris and cutting grass will result in a facility that is both functional and attractive.

Sediment accumulation should be monitored through visual inspection of the basin bottoms and the sediment accumulation depth marker. When the specified depth of sediment has been reached in either the forebay or main basin, the sediment should be removed and disposed of properly, and the forebay or main basin repaired as designed (e.g. proper vegetation replaced).

10.5.2. Sample Operation and Maintenance Provisions

Important maintenance procedures:

- Immediately after the wet detention basin is established, the plants on the vegetated shelf and perimeter of the basin should be watered twice weekly if needed, until the plants become established (commonly six weeks).
- No portion of the wet detention pond should be fertilized after the first initial fertilization that is required to establish the plants on the vegetated shelf.
- Stable groundcover should be maintained in the drainage area to reduce the sediment load to the wet detention basin.
- If the basin must be drained for an emergency or to perform maintenance, the flushing of sediment through the emergency drain should be minimized to the maximum extent practical.
- Once a year, a dam safety expert should inspect the embankment.

After the wet detention pond is established, it should be inspected **once a month and within 24 hours after every storm event greater than 1.0 inches (or 1.5 inches if in a Coastal County)**. Records of operation and maintenance should be kept in a known set location and must be available upon request.

Inspection activities shall be performed as follows. Any problems that are found shall be repaired immediately.

Table 10-6
Sample Operation and Maintenance Provisions for Wet Detention Basins

BMP element:	Potential problems:	How to remediate the problem:
The entire BMP	Trash/debris is present.	Remove the trash/debris.
The perimeter of the wet detention basin	Areas of bare soil and/or erosive gullies have formed.	Regrade the soil if necessary to remove the gully, and then plant a ground cover and water until it is established. Provide lime and a one-time fertilizer application.
	Vegetation is too short or too long.	Maintain vegetation at a height of approximately six inches.
The inlet device: pipe or swale	The pipe is clogged.	Unclog the pipe. Dispose of the sediment off-site.
	The pipe is cracked or otherwise damaged.	Replace the pipe.
	Erosion is occurring in the swale.	Regrade the swale if necessary to smooth it over and provide erosion control devices such as reinforced turf matting or riprap to avoid future problems with erosion.
The forebay	Sediment has accumulated to a depth greater than the original design depth for sediment storage.	Search for the source of the sediment and remedy the problem if possible. Remove the sediment and dispose of it in a location where it will not cause impacts to streams or the BMP.
	Erosion has occurred.	Provide additional erosion protection such as reinforced turf matting or riprap if needed to prevent future erosion problems.
	Weeds are present.	Remove the weeds, preferably by hand. If pesticide is used, wipe it on the plants rather than spraying.

Table 10-6, continued
Sample Operation and Maintenance Provisions for Wet Detention Basins

BMP element:	Potential problems:	How to remediate the problem:
The vegetated shelf	Best professional practices show that pruning is needed to maintain optimal plant health.	Prune according to best professional practices
	Plants are dead, diseased or dying.	Determine the source of the problem: soils, hydrology, disease, etc. Remedy the problem and replace plants. Provide a one-time fertilizer application to establish the ground cover if a soil test indicates it is necessary.
	Weeds are present.	Remove the weeds, preferably by hand. If pesticide is used, wipe it on the plants rather than spraying.
The main treatment area	Sediment has accumulated to a depth greater than the original design sediment storage depth.	Search for the source of the sediment and remedy the problem if possible. Remove the sediment and dispose of it in a location where it will not cause impacts to streams or the BMP.
	Algal growth covers over 50% of the area.	Consult a professional to remove and control the algal growth.
	Cattails, phragmites or other invasive plants cover 50% of the basin surface.	Remove the plants by wiping them with pesticide (do not spray).
The embankment	Shrubs have started to grow on the embankment.	Remove shrubs immediately.
	Evidence of muskrat or beaver activity is present.	Use traps to remove muskrats and consult a professional to remove beavers.
	A tree has started to grow on the embankment.	Consult a dam safety specialist to remove the tree.
	An annual inspection by an appropriate professional shows that the embankment needs repair.	Make all needed repairs.
The outlet device	Clogging has occurred.	Clean out the outlet device. Dispose of the sediment off-site.
	The outlet device is damaged	Repair or replace the outlet device.
The receiving water	Erosion or other signs of damage have occurred at the outlet.	Contact the local NC Division of Water Quality Regional Office, or the 401 Oversight Unit at 919-733-1786.

Figure 10-5: Example Clean Out Diagram

The measuring device used to determine the sediment elevation shall be such that it will give an accurate depth reading and not readily penetrate into accumulated sediments.

When the permanent pool depth reads _____ feet in the main pond, the sediment shall be removed.

When the permanent pool depth reads _____ feet in the forebay, the sediment shall be removed.

BASIN DIAGRAM

(fill in the blanks)

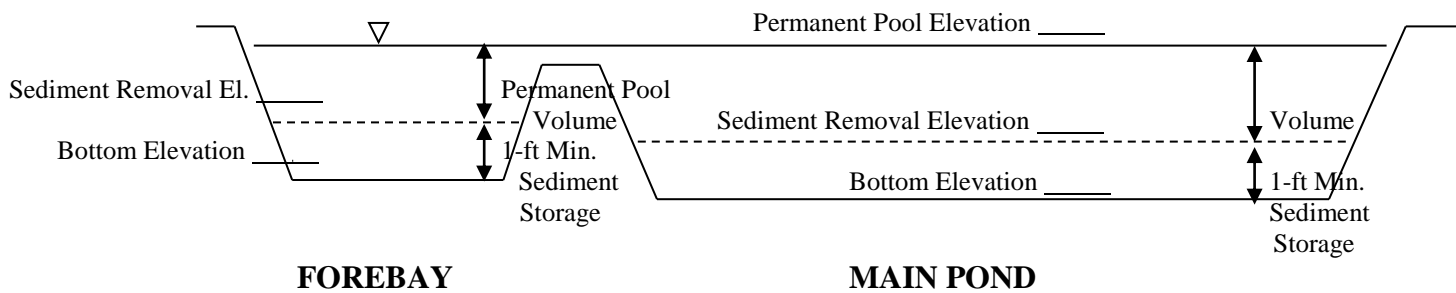

September 28, 2007 Changes:

1. Major Design Elements:
 - i. Reformatted to include numbered requirements.
 - ii. Clarified the filter strip requirements for ponds designed to remove 90% TSS. The requirement now reads, “Basin discharge shall be evenly distributed across a minimum 30 feet long vegetative filter strip unless it is designed to remove 90% TSS. (A 50-ft filter is required in some locations.)”
 - iii. For clarification, the word “full” was removed from, “A minimum 10-foot wide vegetated shelf shall be installed around the full perimeter.”
 - iv. Added “The pond shall be designed with side slopes no steeper than 3:1.” per 15A NCAC 02H .1008(e)(8). The vegetated 3:1 requirement was already included per 15A NCAC 02H .1008(c)(2).
 - v. Added, “If any portion is used for S&EC during construction must be cleaned out and returned to design state.” per 15A NCAC 02H .1008(c)(7).
 - vi. Added, “The design storage shall be above the permanent pool.” per 15A NCAC 02H .1008(e)(1).
 - vii. Added, “The flow within the pond shall not short-circuit the pond.” per 15A NCAC 02H .1008(e)(4).
2. 10.3.2: Added, “Two retaining walls may be used, as shown in Figure 10-3. Or, the design may be altered to contain only one of the two shown,” to clarify the wet pond design requirements when retaining wall(s) are used.
3. 10.3.5: Removed a reference to the Simple Method, and specified that the treatment volume shall be calculated as specified in Section 3.
4. 10.3.6: Added “in addition to the permanent pool volume” to, “DWQ requires that engineering designs for wet detention basins include at least one additional foot of depth for sediment storage in addition to the permanent pool volume.” This is also shown in Figure 10-2b and 10-3.
5. 10.3.7: Added a reference to the vegetated shelf planting requirements in Chapter 6 and the list of appropriate wetland plantings for the vegetated shelf in Chapter 9.
6. 10.3.9: Clarified the filter strip requirements for ponds designed to remove 90% TSS.
7. 10.3.10: Added guidance for decorative fountains.
8. 10.5.2: Deleted references to “aquatic shelf”. Replaced with “vegetated shelf”.
9. Figure 10-2a: Renumbered (previously Figure 10-2). Altered previous diagram for clarification. (Plan view wet pond requirements.)
10. Figure 10-2b: Added a figure showing a cross-section of wet pond requirements.
11. Figure 10-3: Added a figure showing the retaining wall option.
12. Figure 10-4: Renumbered. Previously Figure 10-3.
13. Figure 10-5: Added and example clean out diagram for clarification.
14. Table 10-3: Added 90% TSS SA/DA table for the piedmont region.
15. Table 10-4: Renumbered. Previously Table 10-3.
16. Table 10-5: Added decorative fountain pump horsepower requirements.
17. Table 10-6: Renumbered. Previously Table 10-4.

June 16, 2009 Changes:

1. Various changes throughout the chapter to terminology and/or wording.
2. Corrected a typo in SA/DA Table 10-2.
3. Added a second option for calculating average depth.
4. Clarified when fountains are not allowed.
5. Added more flexibility for the grade of the slope below the vegetated shelf.
6. Clarified requirements regarding the permanent pool elevation with respect to the SHWT.

7. Clarified design information when using existing non-regulated ponds and/or deep ponds.
8. Added guidance for using stormwater ponds for irrigation.
9. Clarified where around the pond the vegetated shelf is required.
10. Clarified that the SA/DA tables are shown in percentages.
11. Clarified freeboard requirement.
12. Clarified forebay sizing requirement.
13. Clarified what volume of water is to be released in the 2-5 day period.
14. Added guidance for setting the elevation for the forebay berm.
15. Clarified that wetland seed mix is not allowed to satisfy the vegetated shelf planting requirement.
16. Added additional guidance for plants on the vegetated shelf.

April 18, 2016 Changes:

1. The pollutant removal was updated from 25% to 30%.