

North Carolina Weatherization Installation Standard Work Specifications



Effective Date:
7/1/24

ACKNOWLEDGEMENTS

These standards were developed by weatherization staff working in conjunction with the North Carolina Weatherization Assistance Program network service providers. The Department wishes to express our deepest appreciation to the individuals that contributed comments and suggestions. These standards were made possible through funding provided by the U.S. Department of Energy's Weatherization Assistance Program, DOE Award Agreement # EE0009920, CFDA# 81.042 and the U.S. Department of Health and Human Services' Low-Income Home Energy Assistance Program funds, DHHS Agreement # 22B1NCLIEA & 239B1NCLIEA, CFDA #93.568.

Disclaimer: The information, data, or work presented herein was funded by the *Weatherization funders* of the United States Government. Neither the United States Government nor any Weatherization service provider thereof, nor any of their employees, makes any warranty, express or implied, or assumes any legal liability or responsibility for the accuracy, completeness, or usefulness of any information, apparatus, product, or process disclosed, or represents that its use would not infringe privately owned rights. Reference herein to any specific commercial product, process, or service by trade name, trademark, manufacturer, or otherwise does not necessarily constitute or imply its endorsement, recommendation, or favoring by the United States Government or any Weatherization funder thereof. The views and opinions of authors expressed herein do not necessarily state or reflect those of the United States Government or any Weatherization funders.

SUMMARY OF CHANGES SINCE VERSION 2023

- 1) 2100 Weatherization Assistant Web-Based Audit Tool - NCWAP will be adopting the single family and multifamily US DOE "Climate Region 2" priority lists (PLs) for optional use in the NCWAP program. If a dwelling unit needs measure(s) that are not included within the PL, or if the unit does not meet the basic requirements of the PL, then a site-specific energy audit will be required to be run utilizing DOE approved software (i.e., Weatherization Assistant for the Web (WAweb) for single family and TREAT for multifamily) and according to the dwelling type audit protocol.
- 2) 22100 Weatherization Assistant Web-Based Audit Tool - NCWAP will be adopting the single family US DOE "Climate Region 2" priority lists (PLs) for optional use in the NCWAP program. If a dwelling unit needs measure(s) that are not included within the PL, or if the unit does not meet the basic requirements of the PL, then a site-specific energy audit will be required to be run utilizing DOE approved software (i.e., WAweb) and according to the dwelling type audit protocol.

SUMMARY OF CHANGES SINCE VERSION 2022:

- 1) 7600 HVAC System Replacements – Justification for replacing a system versus repairing a system: the threshold for the cost of the repair has been changed from 1/3 (33%) to 25%. If a repair will cost 25% or more of the cost of replacing the system, replacement is allowed.
- 2) 7610 Replacement System Efficiency requirements – This chart has been updated to reflect the new DOE efficiency requirements for split system heat pumps and packaged heat pumps.

SUMMARY OF CHANGES SINCE VERSION 2019:

- 1) 1600- No skipping measures with DOE funds.
- 2) 1700- Re-Weatherization/Re-HARRP means that 15 years has passed since the previous Weatherization/HARRP jobs were completed.
- 3) 1800- Deferral of Service edits in line "B)".
- 4) 2100- 100% of DOE weatherized dwellings and 5% of LIHEAP weatherized dwellings require a computerized audit (NEAT or MHEA).
- 5) 2310- We have a New Electronic Residential Energy Audit Tool version 2021.
- 6) 2430- SHPO verification must be entered in the dwelling section of AR4CA. Also, if SHPO denies the measure requiring approval, the measure(s) must be removed from the work order. In this case a computerized audit must be performed without the measure and the house must have an overall Savings Investment Ratio (SIR) of 1.0 or greater.
- 7) 3100- New LIHEAP Priority List for site-built dwellings.
- 8) 4200-Health & Safety website added for pamphlets.
- 9) 5000- Energy-Related Health & Safety edits in lines "A) & B)".
- 10) 5621-Carbon Monoxide Alarms required on every occupiable level, including basements; electrochemical sensor with not less than 10-year warranty.
- 11) 5631-Smoke Alarms installed outside each separate sleeping are within 21 ft of door; replace existing smoke alarms if past the manufacturer's expiration date; do not replace existing is not passed manufacturer's expiration date.
- 12) 5640-Knob & tube wiring must be replaced with health & safety or leveraged funds or dwelling deferred.
- 13) 5670- New link for Radon Gas EPA website.
- 14) 5720- Dryer Exhaust Venting R8 insulation; not exceed 35 ft. length; backflow damper no pest screen; state case-by-case approval for indoor dryer vent kit.
- 15) 5730- Vapor barrier no contact with non-treated structural wood; vapor barrier also extended up piers;

reverse or upslope lapping seems.

- 16) 5810- Changed Mechanical Ventilation pipe from 5" to 6" flex duct and insulate to a minimum of R4. Also, fan flow 80 CFM instead of 70 CFM installed.
- 17) 6230 – Added language allowing bypassing of ductblaster testing and not evaluating ducts in NEAT computer audit if pressure pan readings are below 1 Pascal per duct.
- 18) 6300- Room-to-room pressures are now WRT inside of the dwelling
- 19) 6500- Draft testing aligns with BPI standards.
- 20) 6530- Fuel Fired Clothes Dryer Testing required and repair, if needed.
- 21) 7200- HVAC technicians must complete all applicable sections of HVAC Evaluation Report and note if the unit passes or fails. Also, website added for CFIA Certified Chimney Sweeps.
- 22) 7310 – If baseboard heat is the primary heating system in a dwelling an energy efficient hvac system may be installed.
- 23) 7600 – Wood stove visual inspection and non-combustible floor protector heat shield guidance.
- 24) 7610- Updated to align with federal minimum efficiency standards for heating and cooling equipment.
- 25) 7700-Water heater installation efficiency updates.
- 26) 7800-Window Air Conditioners must be Energy Star rated.
- 27) 10100-Attic Insulation R-38 post weatherization not limited to low-pitched roofs or floored attics, where possible.
- 28) 10140- Changes to Attic Access line "A)". Add latch, lock or frictional device to air seal attic hatches.
- 29) 11100 – Refrigerator SIR – when dwelling requires NEAT or MHEA audit, no separate SIR form required. Non-functioning refrigerator replacement allowed using Non-DOE funds and see other requirements.
- 30) 11300-Wather Heaters insulated R10 or greater; also, see changes B) 4.
- 31) 22100- Weatherization Assistant Energy Audit Software (MHEA) updates for Manufactured Homes.
- 32) 23100- LIHEAP Priority List of Measures added for Manufactured Homes.
- 33) 24130-Mobile Home Mechanical Ventilation use timer or variable speed fan of continuous use with noise rating equal to or less than 1 sone.
- 34) 27210- Room-to-room pressures are now WRT inside of the Manufactured Home.

North Carolina Weatherization Installation Standards

Standard Work Specifications

Table of Contents

Single Family Section

1000 General Programmatic Guidance	8
1100 Scope	8
1200 Effective Date	8
1300 Amendment of Standards	8
1500 Code Compliance	9
1600 Exceptions to Standards	9
1700 Re-Weatherization/Re-HARRP	10
1800 Deferral of Service Based on Site Conditions	10
1900 Enforcement	11
2000 Workflow Documentation	11
2100 Weatherization Assistant Web-Based Energy Audit Software	11
2200 Pre-Audit Documentation	15
2300 Initial Audit Documentation	15
2400 Interim-Audit Documentation	16
3000 "LIHEAP" Priority List of Measures	19
3100 LIHEAP Priority List of Measures for Site-Built Dwellings	19
4000 Client Education & Notification Requirements	19
4100 Energy Education	20
4200 Health and Safety Education	21
4300 Weatherization Process Education	22
5000 Energy-Related Health and Safety	22
5100 Health & Safety Education and Hazard Notification	23
5200 Energy-Related Health and Safety Expenditures	23
5300 Occupant Pre-existing Health Conditions	24
5400 Weatherization & Health and Safety Hazards	25
5500 Jobsite Management Hazards	27
5600 Dwelling-Specific Health and Safety Hazards	29
5700 Mold and Moisture Remediation	36
5800 Indoor Air Quality and ASHRAE 62.2-2016	34
6000 Diagnostic Testing Procedures	37
6100 Pre-Diagnostic Inspections	37
6200 Blower Door Diagnostics and Blower Door Guided Air Sealing	37
6300 Duct Induced Room Pressure Testing	39
6400 Exhaust Fan Flow Meter Diagnostics	39
6500 Combustion Analysis	40

7000 Heating, Ventilating, and Cooling Systems.....	46
7100 ACCA Standard 4.....	46
7200 Evaluate, Clean, and Tune Requirements	46
7300 Mandatory Heat Provision Requirement	47
7400 Initial and Final Weatherization Heating, Ventilating, and Air Conditioning System Evaluation	50
7500 Heating, Ventilating, and Cooling System Repairs	52
7600 HVAC System Replacements	52
7700 Water Heater Repair and Replacement	55
7800 Window Air Conditioner Guidelines.....	56
7900 Thermostat Installation.....	56
8000 Duct Sealing and Insulating.....	57
8100 Duct Sealing Preparation.....	57
8200 Duct Sealing	58
8300 Duct Insulation.....	58
8400 Distribution System Replacement.....	60
9000 Air Sealing Measures.....	60
9100 Air Sealing Precautions.....	61
9200 Primary and Secondary Air Sealing	62
9400 Thermal Bypasses	64
9500 Air Sealing Window Air Conditioners	64
9600 Air Sealing Near Heat Sources.....	65
10000 Insulation Measures.....	65
10100 Attic Insulation	66
10200 Sidewall Insulation.....	70
10300 Floor Insulation	72
11000 Baseload and General Heat Waste	73
11100 Refrigerator Evaluation	73
11200 Lighting Upgrades	75
11300 Water Heat Loss Measures.....	76
11400 Weather stripping and Door Sweep Installation	77
12000 Incidental Repairs	77
Manufactured Home Section	78
22000 Workflow Documentation.....	78
22100 Weatherization Assistant Web-Based Energy Audit Software	78
22200 State Historic Preservation Office Authorization.....	79
23000 “LIHEAP” Priority List of Measures Mobile Homes.....	80
23100 LIHEAP Priority List of Measures for Mobile Homes	80
24000 Health and Safety Provisions.....	81
24110 Vapor Barriers	81
24130 Ventilation.....	81
24140 Lead-Safe/Renovate Right.....	81

25000 Diagnostic Testing	81
25100 Zonal Pressure Diagnostics.....	81
26000 Heating, Cooling, and Ventilating Systems.....	82
26100 Fuel-Fired Heat Source Requirements	82
27000 Duct Sealing and Insulation.....	83
27100 Duct Sealing	83
27200 Distribution System Repair and Replacement.....	83
28000 Air Sealing Measures.....	84
28100 Exterior Storm Windows	84
29000 Insulation Measures.....	85
29100 Roof Cavity Insulation	85
29200 Belly Insulation.....	89
29300 Sidewall Insulation	91
30000 Base Load Reductions	91
30100 Water Heater Reduction Measures	91
31000 Windows and Doors.....	92
Appendix A to Part 440 - Standards for Weatherization Materials.....	93

1000 General Programmatic Guidance

1100 Scope

The mission of the North Carolina Weatherization Assistance Program (NC WAP) is to improve residential energy efficiency and energy-related health & safety conditions and to educate the public about ways to implement and enhance energy conservation strategies. The weatherization program focuses on serving the elderly, disabled, families with children, and heavily energy-burdened households. The goal of NC WAP is to keep North Carolina residents warm in the winter, cool in the summer, and safe all year long.

The State of North Carolina administers both NC WAP and the Heating and Air Repair and Replacement Program (HARRP) on behalf of the federal Department of Energy (DOE) and Department of Health and Human Services (DHHS). As a *grantee* responsible for administration of these federal programs, NC WAP contracts with local weatherization service providers who, as *Subgrantees*, shall be responsible for compliant implementation of program objectives.

The North Carolina Weatherization Installation Standards have been aligned with the National Renewable Energy Laboratory's (NREL) Standard Work Specifications (SWS) and shall govern installation procedures for all weatherization service providers, their representatives, and designees responsible for providing weatherization program services. The Installation Standards shall be divided into major sections as follows:

- A) General Guidance and Site Built, Single Family Dwelling Section
- B) Manufactured Home Section

Questions concerning the content, interpretation, or implementation of the Installation Standards shall be directed to NC WAP.

1200 Effective Date

The effective date for implementation and enforcement of these Installation Standards shall be specified in one attached cover page. All weatherization measures installed or performed by weatherization service providers on or after the effective date(s) specified shall comply with these Installation Standards. Prior versions of the Installation Standards shall be considered null and void.

1300 Amendment of Standards

From time to time the Installation Standards may be amended to reflect changes in state or federal law, technology, or general industry experience and best practices.

Amendments to the Installation Standards shall take effect 30 days from the date of written notification to weatherization service provider unless otherwise indicated. Changes in federal, state law, or DOE guidance may necessitate amendments be made effective immediately upon written notification.

1500 Code Compliance

Correction of preexisting code compliance issues is not an allowable cost other than where weatherization measures are being conducted. No provision in the Installation Standards shall be interpreted in a manner which abridges safety, health, environmental codes, or other local ordinances. All weatherization program services shall comply with applicable local building codes. Local codes more stringent than the Installation Standards shall be followed.

Applicable building, mechanical, electrical, plumbing, insulation, and other permits mandated by local or state code authorities shall be obtained by weatherization service providers either directly or via subcontractors performing the permitted work. Permits shall be obtained prior to commencement of work and copies shall be provided to dwelling owners upon request. Copies of each permit issued, and the associated **passing** final inspection reports shall be maintained in the job file. Actual permit and inspection fees shall be allowed as a materials expense and shall be reasonable and customary.

As local code requirements vary heavily between local jurisdictions, weatherization service providers shall take special care to ensure code requirements are understood and consistently complied with on a per-job basis.

1600 Exceptions to Standards

Deviations from the Installation Standards, except deviations required under applicable local code requirements, shall require written authorization from NC WAP. Deviations from the Installation Standards required under local code shall be well documented and supporting documentation shall be maintained in the job file.

For homes weatherized using DOE funding, a computerized audit must be performed on 100% of dwellings using the Weatherization Assistant web-based (WAweb) software. In dwellings that are weatherized using LIHEAP WAP funding, a computerized audit must be performed on a minimum 5% of dwellings using the WAweb software according to the criteria in section 2100 of this document. The NC WAP approved priority list may be used in other dwellings as long as the dwellings do not meet the criteria in section 2100, and LIHEAP funding is used for weatherization.

Where a dwelling owner or authorized agent of the owner refuses to authorize performance of a required weatherization measure or to allow a previously authorized measure to be completed, weatherization service providers shall determine if weatherization services can still be provided. If DOE funds are being used, no major measures can be skipped by the dwelling owner or authorized agent of the owner; in this case dwelling must be deferred. If LIHEAP weatherization funds are being used, the dwelling owner or authorized agent may refuse the installation of up to one energy efficiency measure and a computerized audit must be completed with a total job SIR of 1 or more with the refused measure removed. No weatherization work shall be performed if the client refuses any combustion remediation, Category A fan in a home with a combustion stove, or Category B fan. Baseload measures not included on the Priority List of Measures or directly tied to Health and Safety may be refused by the client without penalty. In all instances, refusal by the dwelling owner and the justification used to determine appropriate remaining measures to perform shall be documented in the job file.

Local weatherization service providers shall not avoid completing priority weatherization measures by "documenting away" the measure. Weatherization service providers shall never seek or promote refusal of a measure.

1610 Prohibited Measures

Measures and materials not specifically prohibited herein shall not be assumed to be implicitly allowed, but rather weatherization service providers shall request prior written approval from NC WAP prior to performance of any

The following measures and materials shall be specifically prohibited from installation in all dwellings:

- A) Skirting or underpinning of crawl spaces
- B) Foundation vents, except to provide combustion air to combustion appliances
- C) Installation of zippered attic hatch tent kits.

1700 Re-Weatherization/Re-HARRP

Federal regulations authorize the re-weatherization and/or re-harrp of a dwelling if 15 years have passed since the original weatherization services were completed. The client's current application date shall determine if 15 years have passed since weatherization services were completed. Dwellings weatherized within 15 years of the client's current application date may not receive additional services unless the dwelling has been damaged by an act of God and prior state approval has been secured.

Requests to conduct HARRP services in homes that have received HARRP services within 15 years from the completion date of the original HARRP services may be approved if both of the following are true:

- A) The original HARRP job was a repair that equals less than 1/3 the projected cost of replacement, and
- B) The Closure Date of the original HARRP job is less than 12 months from the date of the request for Re-HARRP.

It is the responsibility of the weatherization service provider to ensure that a comprehensive record of previously served dwellings receiving either weatherization or HARRP (per county) is compiled, maintained, and updated regularly to ensure compliance with these guidelines. The status of each subject dwelling with regard to prior weatherization and HARRP at the dwelling shall be verified during the application process and during the energy audit initial inspection and shall be documented in the job file.

A higher priority shall be placed on homes that have not been previously weatherized.

1800 Deferral of Service Based on Site Conditions

Certain health and safety conditions may exist which make weatherization of certain dwellings unfeasible. In such cases, work for eligible households shall be deferred until the conditions can be adequately mitigated or corrected entirely. Where such conditions exist, weatherization service providers shall notify the clients in writing and attempt to resolve such issues as well as pursue reasonable alternatives on behalf of the client, including making referrals.

Conditions requiring that a dwelling to be placed on deferral status shall include, but shall not be limited to:

- A) The dwelling has been condemned or major dwelling mechanical systems have been "red tagged" by licensed subcontractor, local or state code enforcement officials, or utility providers.
- B) The dwelling structure or its mechanical systems, including electrical and plumbing, are in such a state of disrepair that failure is imminent, or the conditions cannot be resolved within cost limitations.
- C) The primary heating system at the dwelling is non-functioning or is functioning improperly and is deemed unsafe and must be replaced, or major repairs are needed and there are insufficient resources available.
- D) Dangerous conditions exist due to high CO levels in combustion appliances which cannot be resolved within weatherization program guidelines.
- E) Moisture problems are so severe they cannot be resolved within program guidelines.
- F) Unsanitary conditions are present in the dwelling that may endanger the health and safety of dwelling occupants or weatherization personnel should weatherization work be performed.
- G) Household members report documented health conditions that prohibit the installation of insulation and other weatherization materials.
- H) Household members, guests, or pets maintained at the dwelling are uncooperative, abusive, or threatening to weatherization staff or contractors.
- I) The extent and condition of lead-based paint or similar hazards in the dwelling may potentially create health and safety risks if weatherization work is performed.
- J) Illegal activities are being conducted in the dwelling unit.
- K) The dwelling has a dryer that cannot be vented to the outdoors. In these cases, contact NC weatherization prior to deferral.

1900 Enforcement

Inability or refusal by weatherization service providers to comply with any of the guidelines set forth by the Installation Standards shall result in administrative action by NC WAP including, but not limited in extreme instances to, termination of the weatherization service provider's award to provide weatherization services.

2000 Workflow Documentation

2100 Weatherization Assistant Web-Based Energy Audit Software

For single family, the Weatherization Assistant web-based (WAweb) suite consists of four audit tools maintained by the Oak Ridge National Laboratory (ORNL) to assist with the implementation of the US Department of Energy's (DOE) Weatherization Assistance Program (WAP). These tools are available for use within WAP and, in certain situations, may be used by utility-based programs and home energy professionals (e.g., in addition to WAP or through previous versions).

WA Suite consists of:

- National Energy Audit Tool (NEAT) for site-built, single-family homes.
- Manufactured Home Energy Audit (MHEA) for manufactured homes.
- Health and Safety Audit for single-family homes (including manufactured homes) and individual dwelling units in multifamily buildings that are being weatherized.

The three energy audit tools identify cost-effective energy-efficiency retrofit measures using site specific weather conditions, construction details, local measure costs, and area fuel costs. The Health and Safety Audit assists in identifying and selecting health and safety measures when a dwelling is evaluated for energy-efficiency retrofits. All tools are available for use through the WAweb platform.

For multifamily:

If reported multi-family dwellings containing five or more units make up less than 20% of the Grantee's weatherized units, then the projects must be submitted for review and approval by DOE prior to commencing work on the units; or

If reported multi-family dwellings containing five or more units make up more than 20% of the Grantee's weatherized units, then the projects must be evaluated by a USDOE-approved energy audit tool (i.e., TREAT, REM, etc.) prior to commencing work on the units. NCWAP will be requesting approval of alternative, DOE approved computer modeling software for use by Subgrantees.

For single family and multifamily:

NCWAP will be adopting the single family and multifamily US DOE "Climate Region 2" priority lists (PLs) for optional use in the NCWAP program for single and multi-family, respectively. This allowance is designed for energy audits to be conducted using predefined lists by housing type when "similar dwelling units without unusual energy-consuming characteristics" exist. The US DOE has determined what these similar dwelling unit types are and what measures should be considered for installation in these dwelling types based on regional differences in climate and energy costs.

These optional regional Priority Lists are not exhaustive and do not include every measure that may be cost effective on a site-specific basis. If a dwelling unit needs measure(s) that are not included within the PL, or if the unit does not meet the basic requirements of the PL, then a site-specific energy audit will be required to be run utilizing DOE approved software (i.e., WAweb for single family and TREAT for multifamily) and according to the dwelling type audit protocol. It is important to note that only one tool can be used at each dwelling unit (i.e., not combining factors/elements between the PL and computerized audit tool). Eligibility must be determined prior to utilizing the PLs and have requirements for Health and Safety measures installed according to the Health and Safety Plan.

Subgrantees may not utilize the PL for USDOE units until the NCWAP Program Manager provides official notification to the network via memorandum.

Use of the above tools shall be required for 100% of DOE weatherized dwellings, and 5% of LIHEAP weatherized dwellings. Network will be notified at a time to be determined when 100% of LIHEAP weatherized dwellings will require a computerized audit. Where measures to be performed on a dwelling deviate from the LIHEAP priority list, a computerized audit must be performed to ensure an SIR on each measure, and overall, of at least 1.0.

Measures requiring the use of the WA software for LIHEAP dwellings shall include, but not be limited to:

- A) Incidental repairs lacking a direct relationship to priority list measures or exceed \$200.00 per repair.
- B) Comparing heating, ventilating, and cooling (HVAC) system sizing for replacements to Manual J calculations.
- C) HVAC sizing for system installations required to establish adequate primary heat sources.
- D) Site built homes with attached garages.
- E) Site built homes with more than 1 addition.
- F) Atypical homes – homes over 2500 square feet, homes with 3 or more cantilevered floors, odd-shaped homes, or extremely modern architecture.
- G) Newer homes built within the last 15 years.
- H) Window and/or door replacements.

Dwellings in which no air sealing is needed and in which adequate insulation in the attic, sidewalls, and floor is already present shall require a WA audit in order to ensure that the entire job will still be cost-effective. The WA software tools may additionally be used to cost-justify refrigerator replacements and to assess the cost-effectiveness of certain health and safety measures, where applicable, to support leveraging and efficient management or program resources.

Computerized audits must be performed before heating systems are evaluated for replacement (ECT). For the heating and cooling portions of the software, the existing system's data shall be entered.

One or more weatherization personnel members employed by each weatherization service provider shall be certified by an approved training facility in the use of the WAweb (NEAT/MHEA).

2110 Photographic Documentation

The job file for every weatherized dwelling shall contain specific photographic documentation of initial, interim, and final weatherization conditions. Circumstances or measures requiring mandatory photographic documentation shall include, but not be limited to:

Initial Audit Pictures:

- A) Exterior pictures of all four (4) sides of dwelling (can be 2 diagonal pics if possible)
- B) Pre-existing conditions of attic or mobile home roof area/crawlspace/basement. Infrared pictures of walls, if possible/ Bath fan reading /Kitchen fan unless kitchen fan is recirculating
- C) Any knee walls/ joists between knee wall attics and conditioned floor space if applicable
- D) Smoke detectors if present
- E) CO detectors if present
- F) Water Heaters/ pipes /discharge pipes
- G) Dryer vents at connection /in unconditioned space /outside vent
- H) Showerheads/aerators if present at sinks/light blubs
- I) Any damning/blocking needed for chimney, flooring, unconditioned areas
- J) Attic hatch condition /attic stairs and hatch condition
- K) Belly condition
- L) Duct boots at supply and returns, interior
- M) Ducts in unconditioned space or spaces/basements/attics
- N) Roof cap condition if applicable
- O) Heating Units /inside and out with model and serial numbers/ thermostats
- P) Fridge data tags fridge meter with Kwh usage if applicable
- Q) Walls
- R) Blower door pics
- S) Combustion testing
- T) Zonal of Attic /Crawl/basement and/or garage if applicable
- U) Some pressure pan readings
- V) Room pressure readings
- W) Ductblaster readings, total and outside leakage if applicable
- X) Supply and return pressure pics if applicable

Interim Pictures:

- A) Air sealing in attic /crawl space /basement/anywhere in progress or completed
- B) Any knee wall insulation installed before air barrier installed /wall insulation in progress if applicable/lead safe prep if applicable
- C) Air sealing in belly if applicable; air sealing around main supply plenum mandatory!
- D) Interim blower door pics
- E) Combustion testing if applicable
- F) Zonal of Attic /Crawl
- G) Some pressure pan readings

Final Inspection Pictures:

- A) Spot check of air sealing in attic /crawl space/interior/basement/where possible
- B) Bath fan reading /Kitchen fan when vented to outside
- C) Attic depth markers/ flags / MSDS/Attic tags
- D) Any knee walls showing air sealing
- E) Any installed insulation in attics/ walls with infrared/floors (multiple pictures)
- F) Smoke detectors
- G) CO detectors
- H) Water heaters/ pipe insulation /discharge pipes
- I) Dryer vents at connection /in unconditioned space (wrapped)/outside vent
- J) Showerheads/aerators/light blubs
- K) Any damning/blocking installed chimney, flooring/attics over unconditioned areas,
- L) Attic hatch /lid (showing R38 on top of lid) or attic stair box showing R-38 on lid
- M) Joist blocking and air sealing between knee wall attics and conditioned floor space if applicable
- N) Newly installed belly fabric if applicable
- O) Belly patches with stitch staples and wood supports in pictures
- P) Ends of duct work with blocking (mobile homes)
- Q) Roof caps installed
- R) Mastic on ducts inside home/at boots / at trunk line connections; duct insulation if added
- S) New heating Units /inside and out with model /serial numbers/new thermostats
- T) New refrigerator data tags /with pic of the outside also showing name brand
- U) Vapor barriers (pics of being up wall 6") spread out evenly
- V) Pics from IR camera for any insulation installed inside walls
- W) Blower door pics
- X) Combustion testing
- Y) Zonal of Attic /Crawl
- Z) Some pressure pan readings
- AA) Room pressure readings if applicable
- AA) Ductblaster leakage numbers where applicable.

In addition to the above, we also need pictures of:

- A) Conditions resulting in a dwelling being placed on deferral status
- B) Conditions inhibiting installation of priority weatherization measures
- C) Unusual or hazardous conditions encountered during the course of work
- D) Justification for an atypical measure or course of action
- E) Verification of Lead-Safe work practices
- F) Photographs required for State Historic Preservation Office (SHPO) compliance
- G) Existing and replacement appliances or equipment
- H) High-priority measures.

Photographic documentation shall additionally comply with the following minimum specifications:

- A) Images shall be digital
- B) Shall be clear and easy to view
- C) Shall be date and time stamped where feasible
- D) Image source files shall be retained electronically and shall be made available upon request
- E) The quantity of photographs taken shall be adequate to document all applicable circumstances and measures
- F) Shall be printed using a quality color printer, grouping not more than six images per 8 ½ in. x 11 in. letter-sized page
- G) Photographs as specified herein shall be maintained in the job file or electronic version maintained at agency and available upon request.

2200 Pre-Audit Documentation

2210 Permission to Enter Premises Agreement

Weatherization service providers and dwelling owners shall complete a Permission to Enter Premises form (PEP) prior to the start of the initial energy audit in every weatherized dwelling. The PEP not only provides protection for weatherization service providers, including conveying the legal right to enter a dwelling for purposes of inspection and evaluation, but it also serves as formal notification to the dwelling owner of pertinent NC WAP policies and procedures. By signing the PEP, dwelling owners acknowledge their acceptance of responsibility to cooperate with weatherization providers, should the dwelling be determined eligible for services. Under no circumstances shall weatherization personnel enter a dwelling to perform an initial energy audit, or for any other purpose, prior to a PEP being signed by the dwelling owner and the weatherization service provider.

2220 Occupant Preexisting Health Condition Notification

Weatherization service providers shall specifically request and document preexisting health condition reporting by dwelling occupants in every weatherized dwelling, whether reported during application processing, at the time of initial audit, or throughout the course of weatherization work. Precautions shall be taken where applicable to avoid exacerbating preexisting health conditions. Conditions reported, and the associated actions taken, if any, shall be documented in the job file and deferrals communicated to the client in writing.

2300 Initial Audit Documentation

2310 Residential Energy Audit Tool (REAT)

Applicable sections of the new electronic Residential Energy Audit Tool (REAT) version 2021 shall be completed fully in conjunction with every initial dwelling audit performed as per the NC WAP REAT instructions version 2021 provided with the tool. Non-applicable sections of the audit tool shall be marked with the designation of N/A. The REAT shall be used to record initial and interim diagnostic test readings and relevant dwelling specific data including, but not limited to, square footage, existing insulation values, health and safety hazards observed, and the make, model, and type of all existing appliances and heating systems. The REAT shall be provided to weatherization installers and subcontractors where applicable prior to the start of work as a supplement to the dwelling specific scopes of work delivered.

2320 Refrigerator Replacement Evaluation Data

Refrigerator replacement evaluation data shall be maintained in the job file for every dwelling weatherized. Replacement data may be used to perform calculations prepared through use of the NC WAP Refrigerator SIR calculator or the WA software. Replacement evaluation data to be documented shall include, but not be limited to:

- A) Appliance manufacture date, model number, and serial number (where determinable)
- B) kWh/yr. of energy consumption, determined by properly metering the appliance or approved database
- C) SIR calculation data used to determine eligibility for replacement
- D) Photographic documentation showing details of existing appliance (where applicable)
- E) Procurement data for replacement appliance (if not using state contract)
- F) Specification data for replacement appliance
- G) Photographic documentation showing details of replacement appliance (where applicable)
- H) Associated expense entry in the AR4CA materials list

2400 Interim-Audit Documentation

2410 Evaluation, Clean, and Tune

Documentation of a completed Evaluate, Clean, and Tune (ECT) (or the basis for exemption from the requirement) shall be maintained in the job file for every weatherized dwelling. Standard NC WAP ECT reporting documents shall be completed by HVAC technicians performing services and shall record all conditions observed and recommended corrective actions, if any. ECT reports shall contain sufficient details and information to substantiate tasks completed during the ECT, as well as to adequately justify any repair or replacement measures subsequently performed.

2420 Lead-Safe/Renovate Right

In compliance with federal regulations relating to lead paint hazard exposure, weatherization service providers (renovation firms), field personnel (installers and certified renovators), and subcontractors shall jointly be responsible for ensuring that standards governing lead-safe work practices including, but not limited to, the following provisions are at all times adhered to on all site-built dwellings constructed prior to 1978:

- A) Individuals performing activities that disturb painted surfaces on behalf of the firm are either certified renovators or have been trained by a certified renovator.
- B) A certified renovator is assigned to each renovation and performs all of the certified renovator responsibilities.
- C) Renovations performed by the firm are performed in accordance with the work practice standards of the Lead-Based Paint Renovation, Repair, and Painting Program (RRP).
- D) Pre-renovation education requirements of the Lead-Based Paint RRP Program are met.
- E) Mandatory recordkeeping requirements are followed.

Lead-safe documentation including Lead Safe RRP certifications and photographic documentation of Lead Safe practices by shell subcontractor or crew shall be maintained in the job file.

2430 State Historic Preservation Office Authorization

The State Historic Preservation Office (SHPO), located within the North Carolina Department of Cultural Resources, is tasked with identifying and safeguarding historic structures and sites. NC WAP has entered into a programmatic agreement with SHPO to review and authorize use of specified weatherization measures proposed for site-built dwellings 45 or more years old which may adversely impact the historic character of such structures. Where applicable, SHPO verification must be entered in the dwelling section of AR4CA.

Weatherization service providers shall be responsible for implementing procedures to ensure compliance with pre-weatherization SHPO project review standards where any of the following measures are proposed for site-built dwellings 45 or more years old:

- A) Measures requiring holes to be drilled in exterior wood weatherboard (siding)
- B) Measures requiring alteration, major repair, or replacement of wood windows
- C) Measures requiring alteration, major repair, or replacement of front wood entry doors
- D) Measures related to installation of solar thermal devices.

Where any of the above measures are proposed, Weatherization service providers must verify if dwelling is historic or adjacent to a historic dwelling (within 1 block). This must be verified at the following website:

<http://gis.ncdcr.gov/hpoweb/>

If dwelling is found to be historic or adjacent to a historic dwelling and any of the above measures apply, documentation including, but not limited to, the following shall be submitted to SHPO for review and approval prior to proceeding with work:

- A) Physical dwelling address
- B) Name of dwelling owner
- C) Map denoting the location of the dwelling within the state
- D) Copy of preliminary scope of work (work order) for the dwelling detailing proposed measures
- E) Photographs depicting each dwelling elevation (front, rear, and sides).

This SHPO project review documentation shall be submitted by weatherization service providers via electronic mail (only) to: energy.projects@ncdcr.gov. Submission and authorization data and communications shall be maintained in the job file.

If SHPO denies the measure requiring approval, the measure(s) must be removed from the work order. In this case a computerized audit must be performed without the measure and the house must have an overall Savings Investment Ratio (SIR) of 1.0 or greater.

2440 Permission to Perform Services and Preliminary Scope of Work

Every dwelling weatherized shall be subject to a Permission to Perform Services from (PPS) signed by the dwelling owner and the weatherization service provider prior to the start of any work (excepting the initial energy audit). Weatherization service providers shall be responsible for obtaining informed written consent from the property owner for all proposed measures and acknowledging a willingness to comply with program guidelines prior to job start via signed PPS and detailed preliminary scope of work (work order). These minimum standards apply to PPS:

- A) Weatherization measure proposed for the dwelling shall be described in detail in the attached scope of work, including the method of performance and materials to be used.
- B) Only the dwelling owner can sign authorizing work. Both the dwelling owner and the occupants shall have the right to review and understand the results of the initial audit or other inspections and the details regarding each proposed measure prior to the start of work.
- C) Dwelling owners shall have the right to refuse performance of any measure; however, refusal to authorize performance of particular measures may result in non-performance of all or other proposed measures.
- D) Weatherization service providers shall provide information as needed to ensure that owners (and to the extent possible, occupants) possess a thorough understanding of the services that will *and* will not be provided at the dwelling.
- E) Signature by each dwelling owner or co-owner shall be required to authorize work.

2450 Work Orders, Change Orders, and Scope of Work

Standard NC WAP work order and change order documents shall constitute the formal scope of work for weatherization jobs. The terms of standard NC WAP weatherization subcontractor agreements, as well as compliance with NC WAP standards, mandate that a scope of work be issued to weatherization personnel and subcontractors containing detailed specifications for all measures performed on weatherized dwellings. Work orders shall be generated by initial auditors or weatherization management as appropriate, based on dwelling data collected during the initial audit and recorded in the REAT. Work orders and, as needed, change orders shall contain reasonable estimates of labor and material expenses associated with each specified measure and shall be delivered to field personnel and subcontractors prior to installation of the measures specified.

Weatherization personnel and subcontractors shall perform measures as specified in work order and change order documents only. Deviation from the scope of work initially supplied by the weatherization service provider in the form of a compliant work order shall require written documentation and authorization for the revision in scope issued in the form of change order. The scope of work specified in the work orders/change orders for the job shall form the basis by which subcontractors shall be compensated and by which invoices and expenditures submitted to NC WAP shall be evaluated prior to payment.

2460 Prohibition on Smoking and Tobacco Use

NC WAP funded jobsites and vehicles shall at all times be smoke and tobacco-free environments. Cigarette smoking or the use of other tobacco products including, but not limited to, pipes, cigars, snuff, or chewing tobacco by weatherization personnel or subcontractors shall not be allowed on any portion of a weatherization jobsite. A weatherization jobsite shall include the dwelling and the surrounding property on which the weatherized dwelling is located. Use of tobacco products of any type shall also be prohibited inside any vehicle owned, leased, or rented by a weatherization service provider. Failure to adhere to limitations on the use of tobacco products on weatherization jobsites or in WAP funded vehicles may result in administrative action.

2470 Warranty Documentation and Operating Manuals

Manufacturer warranty documentation and operation manuals for all newly installed appliances and equipment shall be obtained from the subcontractor, distributor, or manufacturer and provided to the dwelling owner prior to completion of the final inspection. Every effort shall be made to provide warranty documentation and operation manuals in Spanish or other languages where needed to aid non-English speaking clients.

Final inspectors shall be responsible for ensuring that essential information regarding the proper operation and maintenance of appliances and equipment, as well as instructions for initiating warranty related repairs, is clearly explained to dwelling owners prior to completion of the final inspection and formal acceptance of services.

3000 “LIHEAP” Priority List of Measures

The NC WAP Priority List of Measures for Site-Built Dwellings and Manufactured Housing serves as the basis upon which the majority of weatherization measures shall be performed in North Carolina dwellings. The priority list was developed based on data collected by conducting numerous computerized audits performed on typical low-income housing stock throughout the state using the WA software. Audit data collected identified the following “frequently recommended” measures as being the most cost-effective to perform based on the measures consistently delivering an SIR of 1.0 or greater. The coastal counties are as follows: Beaufort, Bertie, Brunswick, Camden, Carteret, Chowan, Craven, Currituck, Dare, Gates, Hyde, New Hanover, Onslow, Pamlico, Pender, Pasquotank, Perquimans, Tyrrell, and Washington.

A dwelling-specific computerized audit shall be mandated per applicable guidelines herein, particularly where *non-priority list measures* are proposed for a particular dwelling. Energy-related health and safety measures shall be considered on a dwelling-by-dwelling basis and are not subject to cost-effectiveness requirements.

3100 LIHEAP Priority List of Measures for Site-Built Dwellings

1. Energy Related Health and Safety

(Chapters 5000—Energy Related Health and Safety)

2. Duct Sealing and Associated Insulating

(Chapter 8000—Duct Sealing & Insulating)

3. Infiltration Reduction

(Chapter 9000—Air Sealing)

4. Lighting Upgrades (CFLs & LEDs)

(Chapter 11000—Baseload Reduction and General Heat Waste)

5. Refrigerator Evaluation

(Chapter 11000—Baseload Reduction and General Heat Waste)

6. Attic Insulation

(Chapter 10000—Insulation)

7. Dense Pack Sidewalls

(Chapter 10000—Insulation)

8. Floor Insulation – Excludes Coastal Dwellings with Heat Pumps

(Chapter 10000—Insulation)

4000 Client Education & Notification Requirements

Weatherization services provide a greater and more lasting benefit where clients are partners in the process, working alongside weatherization service providers. As in any partnership, each partner in the weatherization process has certain responsibilities and expectations. NC WAP and its network of providers are charged with quality installation of appropriate energy-saving measures intended to reduce fuel and utility expenses in weatherized dwellings and, where possible, to increase comfort for client households. Weatherization clients are responsible for cooperating with reasonable requests made by weatherization service providers before, during, and after weatherization process. Where the weatherization partnership is well balanced, the result can be greater energy savings, lower fuel and utility bills, and increased client comfort.

Delivery of quality client education plays a large role in a balanced weatherization partnership by enabling clients to understand and participate in improving the efficiency of their dwelling. Weatherization client education includes discussion, instruction, brochures, and pamphlets that explain the weatherization process, measures installed and how to use them, low-cost/no-cost ways to save energy, and how to avoid potential dwelling-related safety hazards.

Weatherization service providers shall ensure that weatherization personnel responsible for providing weatherization client education are proficient in the knowledge required to effectively deliver quality client education including, at minimum, possessing a strong working knowledge of:

- A) Basic steps in the weatherization process, including auditing, testing, installation, inspection, and monitoring
- B) Actions that can be taken to reduce energy use in the dwelling
- C) Actions that can be taken to maintain a safe and healthful indoor environment
- D) The purpose and operation of basic equipment involved in the weatherization process, including blower door, pressure pan, combustion analyzer, gas leak detector, insulation blowing machine, and generator
- E) Techniques to demonstrate estimated economic impacts of suggested actions to bolster occupant commitment to changes in household behaviors.

Client education shall be provided at intake or initial audit and shall be repeated as needed to ensure clients are comfortable with the information provided. Client education should include use of the client education flip chart.

4100 Energy Education

Changing household behaviors is a key factor in improving the energy consumption in a dwelling. When household members become aware that choices related to thermostat settings, hot water usage, and switching off unused electrical devices can reduce energy bills, occupants are more likely to adopt energy-saving behaviors.

Client energy education shall be provided to client households in every weatherized dwelling and shall include relevant, dwelling-specific information on energy efficiency improvements including, but not limited to:

- A) Heating and cooling system efficiency
- B) Infiltration and air sealing
- C) Thermal comfort improvements
- D) Indoor air quality (IAQ) improvements
- E) Baseload energy reduction
- F) General heat loss improvements.

4200 Health and Safety Education

In addition to energy education, client households shall also be provided with client health and safety education to advise clients of potential dwelling-related health and safety hazards which may be present, created, or exacerbated by weatherization work.

Mandatory delivery of specific client education and the related reference publication for the following topics shall be provided to *dwelling owners and occupants* in every dwelling prior to the start of weatherization work.

Weatherization educators shall underscore the importance of the information provided for each topic and shall fully answer questions and address concerns raised by clients, if any. The documents can be found, and copies made, at the following websites or on ShareFile:

ShareFile – WAP Subgrantees FY22/FY22 Network Documents/Client Education
Online – www.epa.gov

Carbon Monoxide (CO)—is an odorless, colorless, tasteless, poisonous gas produced by incomplete combustion. CO poisoning poses immediate harm to humans and pets and can be fatal. Any fossil fuel-burning activity including cooking, automobile, or heating system exhaust is a potential source for CO exposure. Every client household shall be educated on the potential health hazards related to CO poisoning and provided with a copy of *The Invisible KILLER*.

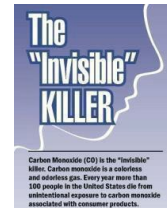

Lead—exposure to lead dust, commonly found in dwellings containing lead-based paint, can adversely affect child brain and nervous system development, causing learning disabilities and behavioral problems. Lead dust exposure is also harmful to adults. Federal law mandate that individuals receive notification of potential lead hazards prior to the start of interior or exterior renovation projects in housing built in or before 1978. Every client household shall be educated on the potential health hazards related to lead dust exposure and provided with a copy of *The Lead-Safe Certified Guide to Renovate Right*. <https://www.epa.gov/lead/lead-safety-documents-and-outreach-materials>



Mold and Moisture—because tightening a dwelling through air sealing may cause an increase in relative humidity levels indoors, dwelling occupants shall be informed about how to identify moisture related problems and possible solutions. Every client household shall be educated on the potential health hazards related to mold and mildew exposure and be provided with a copy of *A Brief Guide to Mold, Moisture, and Your Home*.



Radon—is a naturally occurring, colorless, odorless, tasteless, cancer-causing, radioactive gas found throughout the United States. Tightening a dwelling through air sealing may cause an increase in indoor radon levels. Every client household shall be educated on the potential health hazards of exposure to radon gas and provided with a copy of *A Citizen's Guide to Radon: The Guide to Protecting Yourself and Your Family from Radon*. <https://www.epa.gov/radon/publications-about-radon>

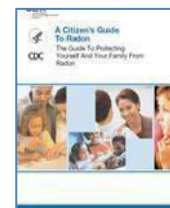

Spray Polyurethane Foam (SPF)—is a widely used and highly effective insulator and sealant. However, exposure to its key ingredient, isocyanates, and other SPF chemicals in vapors, aerosols, and dust during *and after installation* can exacerbate health conditions including asthma, other respiratory conditions, and severe skin and eye irritation. Every client household shall be educated on the potential health hazards related to SPF products and provided with a copy of *Weatherizing your home with SPF*.



A written acknowledgement of receipt for each topic, as well as any related communication on these and other topics shall be maintained in the job file.

Additional client health and safety education topics to be reviewed with client households as needed based on actual conditions present in the dwelling shall include, but shall not be limited to:

- A) Maintaining weatherization jobsite safety
- B) Hazardous materials exposure and proper handling (existing or used during work)
- C) Electrical hazards and fire safety
- D) Structural integrity, fall hazards, or other building durability issues
- E) Biological and sanitation hazards, including insect or rodent infestations, animal dander or feces, raw sewage contamination, or hazards related to the presence of excess debris

4300 Weatherization Process Education

Ensuring a smooth and beneficial weatherization experience also requires that client households be informed and updated regularly about what is expected from throughout the weatherization process.

Aspects of the weatherization process that shall be discussed with client households at various stages throughout the weatherization process shall include, but not be limited to:

- A) Schedule of milestone events in the weatherization and HARRP processes
- B) Who will communicate with the client and when
- C) Events that shall take place before weatherization work can begin
- D) What to expect during the energy audit
- E) Client responsibilities to prepare for weatherization
- F) Who will perform weatherization work
- G) Daily work schedule
- H) Weatherization measures and appliance(s) that will be installed as part of weatherization
- I) Repairs or improvements that will *not* be provided in conjunction with weatherization
- J) Personal property that will be altered or removed during weatherization
- K) When the work will be complete
- L) Final inspection and quality assurance monitoring processes
- M) How the dwelling may perform differently as a result of weatherization
- N) Proper operation and maintenance of new or existing equipment and systems

5000 Energy-Related Health and Safety

While the primary purpose of NC WAP is to reduce energy use for elderly, disabled, and low-income residents, ensuring the health and safety of clients and personnel must always be the most paramount factor for all weatherization service providers and related weatherization professionals.

Allowable energy-related health and safety measures shall be defined as only those specified measures deemed necessary by NC WAP to maintain the physical wellbeing of the dwelling, the dwelling occupants, and weatherization personnel. Energy-related health and safety measures shall be allowable only where energy efficiency measures are also installed.

Effective management and implementation of energy-related health and safety measures require weatherization service providers to clearly understand:

- A) Measures that are necessary to effectively perform weatherization work
- B) Changes in measures or scope of work that are necessary as a result of weatherization work
- C) Expenses that are allowable or required to ensure job site conditions are as safe as possible for weatherization personnel and dwelling occupants before, during, and after weatherization.

The extent to which allowable energy-related health and safety concerns can reasonably be addressed using available health and safety resources is inherently limited; therefore, dwellings must be evaluated on a case-by-case basis. Placing dwellings in deferral status shall be required wherever energy-related health and safety concerns cannot be adequately addressed.

The decision to defer work in a dwelling is difficult but, cannot be avoided in some instances. This does not mean that assistance will never be available, but rather that work must be postponed until health and safety problems can be resolved and/or alternative sources of assistance can be located.

5100 Health & Safety Education and Hazard Notification

Weatherization service providers shall be responsible for providing energy-related health and safety education to client households living in every dwelling weatherized in compliance with applicable standards herein for mandatory client education. This responsibility shall specifically apply to educating clients about the potential risks and necessary safety precautions associated with each section of this chapter.

In every instance weatherization service provider shall be responsible for notifying property owners and dwelling occupants, both verbally and in writing, of pertinent facts and necessary safety precautions relating to any conditions observed on a jobsite that could result in harm or loss to either life or property. Examples of such conditions may include, but shall not be limited to, code compliance issues, existing or potential health and safety hazards, or any atypical condition encountered on the jobsite.

Notification requirements shall apply to all activities undertaken in conjunction with the provision of weatherization program services and to *all* sections of the Installation Standards. Notification requirements shall include observation of hazard conditions that may fall outside the scope of weatherization activities.

5200 Energy-Related Health and Safety Expenditures

Allowable energy-related health and safety measures, where provided in conjunction with required energy efficiency measures and in compliance with applicable standards and limitations shall include, but not be limited to:

- A) Repairing or replacing unsafe, nonfunctioning, or inadequate HVAC systems or components

- B) Correcting IAQ issues
- C) Preventing excess moisture intrusion
- D) Repairing minor plumbing problems
- E) Repairing or replacing leaking or unsafe water heaters
- F) Repairing minor electrical problems
- G) Installing carbon monoxide and smoke alarms
- H) Repairing unsafe fuel-fired cook stoves
- I) Lead testing using approved lead test kits
- J) Performing lead-safe work practices
- K) Properly addressing asbestos
- L) Purchasing personal protective equipment (PPE)
- M) Procuring one-time pest or termite control service
- N) Testing for radon in moderate to high potential risk areas
- O) Removing excess debris from dwellings in limited instances.

Prohibited activities shall be defined as activities which are not permitted by NC WAP under any circumstances and as those activities conducted in a manner which does not comply with applicable NC WAP technical standards or administrative guidelines.

Prohibited activities shall include, but not be limited to:

- A) Treating to kill viruses or bacteria
- B) Installing or repairing portable or unvented space heaters
- C) Installing or repairing attic, ceiling, or portable fans
- D) Installing or repairing heat recovery ventilators or energy recovery ventilators
- E) Installing or repairing humidifiers or dehumidifiers
- F) Installing or repairing wheelchair ramps or bathroom grab bars
- G) Installing or repairing septic tanks, covers, or lines
- H) Installing toilets and tubs
- I) Auguring clogged drains
- J) Installing or repairing windows and doors*
- K) Installing or repairing refrigerators*
- L) Installing cook stoves
- M) Installing any appliance not expressly specified as an allowable energy-related health and safety measure including, but not limited to, clothes washers or dryers, dishwashers, microwaves, and stand-alone freezers.

This list of prohibited or disallowed activities shall **not** be considered exhaustive. Where clarification of prohibited or disallowed activities is required, weatherization service providers shall be responsible for contacting NC WAP prior to any expenditure of health and safety resources. Misappropriation of energy-related health and safety resources to perform prohibited activities shall result in the expenditure being disallowed.

*Under no circumstances shall repair or replacement of refrigerators, windows, or doors be allowed as an energy-related health and safety measure.

5300 Occupant Pre-existing Health Conditions

Special precautions shall be taken where any occupant of a weatherization-eligible dwelling suffers from respiratory ailments, allergies, is pregnant, or has a similar health condition that puts the occupant at greater potential risk for medical complications as a result of any aspect of weatherization work. It shall be the responsibility of the weatherization service provider to document any such condition reported by any member of the client household, whether during the application process, at the time of initial audit, or as work progresses

and to immediately inform weatherization workers of any precautions that must be taken to avoid exacerbating the reported health condition.

In particular circumstances, temporary relocation of at-risk household members may be the most appropriate course of action to avoid potential exposure to hazardous conditions. Weatherization service providers shall communicate with client households in advance of scheduling weatherization services to identify viable personal alternatives that may be arranged by the dwelling occupants for temporary relocation; for example, temporary relocation to the home of a friend or relative. In extreme circumstances, it may be necessary for the weatherization service provider to provide for temporary relocation of the at-risk household member. Authorization for the use of health and safety resources to provide for temporary relocation shall be considered in extreme circumstances and on a case-by-case basis and may be expended only with the prior written consent of NC WAP.

Where weatherization personnel encounter clients suffering from bacterial infections or viruses known to be contagious, weatherization service provider management shall be contacted and, where instructed, work may be deferred to allow for the individual suffering from the illness to recover and the contagious period for the specific illness to pass.

Where a weatherization service provider is for any reason unable to implement necessary precautionary measures or to take actions required to avoid the potential for exacerbation of pre-existing occupant health concerns (including refusal by the dwelling occupants to reasonably comply with requests for temporary relocation), the dwelling shall be placed in deferral status and no weatherization work shall be performed until adequate safety precautions can be implemented.

Documentation and required notifications related to any such instance shall be maintained in the job file.

5400 Weatherization & Health and Safety Hazards

Weatherization program services shall at all times be provided in a manner that minimizes risk to client households. Any conditions which exist that may endanger the health or safety of the dwelling occupants and which cannot be resolved within the scope of allowable health and safety measures shall result in the dwelling being placed in deferral status until the conditions can be corrected.

Precautions to ensure occupant and worker health and safety shall at all times include the responsibility of weatherization service providers, personnel, and contractors to recognize potential hazards related directly to weatherization work and to take action to limit exposure to, or exacerbation of, the potentially hazardous condition.

5410 Blower Door Operating Hazards

As a standard practice, blower door diagnostic testing shall be performed only after a dwelling has been thoroughly inspected, potential hazards identified and, where required, necessary precautions taken to remove, encapsulate, or otherwise mitigate the hazard to a level at which blower door diagnostics can safely proceed. Where risks related to weak ceiling tiles or other structural issues exist, performing blower door diagnostics using the pressurization, rather than the depressurization method, may be appropriate. Where hazardous

materials such as asbestos or vermiculite insulation exist that may be circulated, blower door diagnostics shall not be performed.

5420 Spray Polyurethane Foam

Spray polyurethane foam (SPF) is a widely used and highly effective insulator and sealant. However, exposure to its key ingredient, isocyanates, and other SPF chemicals in vapors, aerosols, and dust during and after installation can exacerbate:

- A) Asthma, a potentially life-threatening disease
- B) Sensitization, which can lead to asthma attacks if susceptible
- C) Other respiratory and breathing problems
- D) Skin and eye irritation.

The minimum safety precautions required where SPF is used shall include, but not be limited to:

- A) Ensuring health and safety training is completed and safe work practices are followed to prevent eye, skin, and inhalation exposures during and after SPF installation
- B) Exercising caution when determining safe re-entry times for unprotected dwelling occupants and workers based on the manufacturer's recommendations
- C) Regular review of label and product information for ingredients, hazards, directions, safe work practices, and precautions

Providing ventilation in confined spaces such as attics and crawlspaces while SPF is being applied, such as a fan or other method of circulating air in the confined space.

Weatherization service providers shall minimize or restrict the use of materials that may be hazardous to the client to the extent feasible; however, where the weatherization service provider must allow the use of hazardous chemicals or materials, the contents, precautions, and potential consequences of exposure to the hazard shall be disclosed in writing to both the dwelling owner and the dwelling occupants prior to use and the parties must sign to acknowledge understanding of the information provided and to grant consent to proceed with work prior to use of the chemical or material. Documentation of the notification and consent shall be maintained in the job file. Installation of hazardous materials shall always be performed in ventilated areas to the full extent practical. SPF shall never be used where the foam will be visible by a casual inspection of the main living areas (e.g., interior ceiling wall junctions).

5440 Formaldehyde and Volatile Organic Compounds

Substances containing formaldehyde, volatile organic compounds (VOCs), and similar air polluting agents which pose a potential risk to weatherization workers and dwelling occupants shall be identified and, where feasible,

removed from the dwelling prior to weatherization work commencing. Where it is not feasible to remove such pollutants, care shall be taken not to disturb the substances and to limit exposure to the extent possible.

5500 Jobsite Management Hazards

5510 Excess Debris and Personal Property

Excess debris and other items located in and around dwelling units may not only pose potential health and safety risks to weatherization workers and dwelling occupants, but likely also inhibits proper execution of weatherization measures. Weatherization service providers shall be responsible for identifying and mitigating any such hazardous conditions prior to proceeding with weatherization services.

Where feasible, weatherization service providers may request that clients be responsible for the removal of excess debris and personal property from the dwelling. Where the property owner and/or the dwelling occupants are incapable of removing the items, it shall be allowable for weatherization service providers to provide for a reasonable amount of removal. All personal property surrendered or removed from a dwelling by weatherization personnel or contractors shall be documented in the job file, including written authorization from the dwelling owner as well as photo documentation of items removed.

Emphasis shall be placed on removing excess debris or extraneous items from attics, crawl spaces, the dwelling perimeter, and exterior doorways.

Large amounts of excess clutter contained in dwellings includes trash, clothing, collectables, toys, boxes, building materials, furniture, machinery, tires, or similar items which inhibit the ability of weatherization workers to fully access all areas of the dwelling to perform inspections and repairs or to install measures. The excess clutter poses greater potential hazards to weatherization workers and dwelling occupants, in addition to inhibiting the proper execution of weatherization measures. Where excessively cluttered conditions exist, effort shall be required either by the client or the weatherization service provider, as appropriate, to substantially de-clutter the dwelling prior to weatherization work commencing.

5520 Biological Hazards and Poor Sanitation

Unsanitary dwelling conditions contribute to a host of potential biological hazards that can cause illnesses. Dwelling occupants are often unaware of household conditions that may promote biological hazards.

Weatherization service providers shall educate clients, where applicable, on locations within a dwelling (for example kitchens, bathrooms, and doorknobs) where biological hazards may be present, as well as regular housekeeping, food storage, and hand washing techniques essential to maintaining a safe and sanitary home.

Weatherization personnel shall be trained to identify and properly manage situations where potential biological hazards are encountered. For example, proper management of raw sewage discovered in a crawl space might consist of steps such as:

- A) Ceasing all crawl space work to avoid contact with the potential hazard
- B) Notifying weatherization management and the dwelling occupants that a potentially hazardous condition has been identified and should be avoided until corrected

- C) Documenting the circumstances surrounding identification of the hazard in the job file
- D) Procuring services from a licensed plumber to assess and then correct the problem where only a minor issue exists
- E) Taking steps to avoid any future contact with the hazard, including allowing the area to dry completely prior to resuming work and ensuring personnel wear PPE while working in the crawl space.

Measures to remediate conditions that may lead to or promote biological hazards shall be considered on a case-by-case basis. Measures intended specifically to eliminate the presence of bacteria and or viruses shall not be allowed. Where extreme conditions exist that are outside the scope of allowable health and safety measures, the dwelling shall be placed in deferral status until the conditions corrected.

5530 Insects and Rodents

Where mild or moderate insect or rodent infestation exists, the use of respirators and protective clothing shall be of even greater importance to avoid inhalation and skin contact with droppings. Protective goggles shall additionally be advisable to prevent contact through the eyes. Where severe insect or rodent infestations exist in a dwelling which may hinder safe weatherization work by endangering clients or workers, extermination or removal by a properly trained and/or licensed extermination professional shall be allowable. Extermination, where performed, shall be completed in advance of weatherization work commencing. In the case of insecticide applications, sufficient time shall be allowed for complete ventilation of treated areas to avoid unnecessary inhalation of the insecticides.

Written authorization by the dwelling owner and notification acknowledgment by the dwelling occupants shall be required prior to weatherization service providers procuring any insect and rodent removal treatment or services, and documentation of all services and related authorizations and acknowledgements shall be maintained in the job file. Where infestations are particularly serious, notifying the local health department may be advisable.

Hazards related to insect or rodent infestations may include, but shall not be limited to, the following:

- A) Bees and Wasps
Flying insect stings can cause severe allergic reactions, and in rare instances may result in death
- B) Roaches, Fleas, Rats, and Mice
Extreme crawling insect infestations may be hazardous to the health of dwelling occupants and weatherization workers since contact with droppings or feces may cause infectious diseases. Disinfectant wipes may be needed to cleanse skin and contaminated areas, as soap and water alone may not kill harmful feces-related bacteria. Medical attention shall be sought for a rat or mouse bite, or for flea or roach bites that cause extreme irritation.
- C) Bats
Work performed where bat feces or guano is present may present even greater potential hazards.
- D) Snakes
Snakebites shall require that the individual bitten be transported to a medical facility immediately, particularly if the person was bitten by a snake confirmed as being venomous. First aid may be required prior to or during transport.

5540 Dwelling Accessibility Limits

As a practical consideration, as well as a health and safety matter for weatherization personnel, weatherization measures shall not be required in portions of a dwelling crawl space where clearances of 24 in. or less as measured from the bottom of the floor joists to the ground below exist.

Where crawl space clearances restrict access to portions of a crawl space, priority weatherization measures including, but not limited to, vapor barrier installation, air sealing, and installing insulation shall be required in the accessible portions of the crawl space.

Though measures shall not be required in crawl space areas with clearances of 24 in. or less, reasonable efforts shall be made on the part of weatherization service providers and weatherization personnel to complete measures to the fullest extent practical in an effort to provide the greatest potential benefit to clients.

5550 Jobsite Injury Prevention

Weatherization service providers shall take all reasonable precautions against performing work on dwellings where that work will subject weatherization personnel or dwelling occupants to health and safety risks, including risk of falls. *Minor* repair shall be allowable to secure steps and handrails where such actions are necessary to effectively weatherize the dwelling. Measures deemed unnecessary or excessive shall be prohibited.

5560 Jobsite Awareness and Communication

Weatherization service providers shall be responsible for ensuring that all weatherization personnel and subcontractors are knowledgeable and capable of understanding and communicating potential safety concerns to dwelling occupants on an ongoing basis as the weatherization job progresses. Clients shall be educated prior to the start of work on the necessity to secure the work area to avoid injuries to adults, children, and pets, and weatherization personnel and subcontractors shall be responsible for continual reinforcement of this education.

Clients shall be responsible for ensuring weatherization tools, equipment, or materials on the jobsite are not disturbed, and likewise weatherization workers shall be responsible at all times for securing such items on the jobsite and leaving a reasonable pathway for dwelling occupants to move about wherever possible, which allows them to avoid contact with potential hazards.

Where weatherization personnel encounter circumstances where they cannot reasonably secure the work area or where there is a failure by the client to avoid work disturbances by people and/or pets, weatherization personnel and contractors shall notify weatherization service provider management and cease work where necessary until such time as a safe work area can be established on the jobsite.

5600 Dwelling-Specific Health and Safety Hazards

5610 Emergency Situations

During the course of an audit or weatherization work, situations may be encountered which warrant immediate action; for example, the presence of elevated CO levels or a fire. Weatherization service providers shall be responsible for determining the safest and most prudent course of action should an emergency situation be encountered, including determining whether or not the client may safely remain in the dwelling. Utility providers and local jurisdictions may have specified emergency response protocols which shall be respected. Documentation of actions taken in the event of an emergency shall be maintained in the job file.

5620 Carbon Monoxide Poisoning

Carbon monoxide (CO) is an odorless, colorless, tasteless, and poisonous gas produced by incomplete combustion. Even limited exposure to high levels of CO or CO poisoning can result in serious illness and/or death. Due to the extremely hazardous nature of CO poisoning, weatherization service providers shall be responsible for testing, identifying, documenting, and correcting conditions that contribute to CO levels inside dwelling units that are in excess of applicable standards.

All fuel-fired appliances including, but not limited to, furnaces, boilers, domestic water heaters, cooking appliances, and clothes dryers shall be safety tested using allowable combustion testing methodology and diagnostic equipment. Direct-vent and sealed combustion appliances need not be draft tested, but levels shall be tested as a matter of precaution. All combustion appliances present in the dwelling, regardless of age or date of installation, shall be tested at specified intervals per applicable standards for combustion testing referenced herein.

The results of all CO testing performed, as well as the details of any actions taken to correct elevated CO levels, shall be documented in the job file.

5621 Carbon Monoxide Alarms

Not less than one properly functioning carbon monoxide alarm shall be required on every occupiable level of the home, including basements. Existing carbon monoxide alarms that are functioning properly at the time of the initial audit shall not be replaced. Where installed, carbon monoxide alarms shall be equipped with:

- A) A digital liquid crystal display (LCD).
- B) An alarm capable of producing 85 decibels at a distance of 10 ft.
- C) An electrochemical sensor with a warranty of not less than 10 years.

Excepting instances where the Installation Standards conflict with manufacturer specifications or local codes, carbon monoxide alarms shall be installed such that the devices are:

- A) Located on every occupiable level of the home including basements.
- B) Located not less than 15 ft. away from any fuel-fired appliance.
- C) Located as close to each main sleeping area (multiple alarms may be required for dwellings with multiple sleeping areas).
- D) Not located in proximity to high moisture areas such as bathrooms.
- E) Located at the optimal height as specified by the device manufacturer.

As of the effective date of the Installation Standards, NC WAP is unaware of any combination unit that meets the minimum applicable standards for both carbon monoxide and smoke alarms. Combination carbon monoxide/smoke alarms that meet the minimum standards for both devices listed (should such devices become available in the future) shall be allowable.

Weatherization service providers shall ensure that clients are well educated regarding the purpose and operation of carbon monoxide alarms, the actionable carbon monoxide levels for their device, and the appropriate safety precautions to take, should an alarm occur.

5630 Fire Hazards

Weatherized dwellings shall be inspected for conditions which pose potential fire hazards. Reasonable efforts shall be made to eliminate existing or potential fire hazards where encountered. Eliminating many potential fire hazards can often be accomplished through greater client education with relatively limited resource expenditures. Installation of fire extinguishers shall be allowed on a limited case-by-case basis in dwellings where compliant solid-fuel burning appliances (wood, pellet, or coal) are present and where the extinguishers provided are appropriate for the purpose intended.

5631 Smoke Alarms

Smoke detectors that meet the following criteria shall be installed in all dwellings:

- A) In each sleeping room.
- B) Outside each separate sleeping area within 21 ft of any door to a sleeping room, with the distance measured along a path of travel in the immediate vicinity of the bedrooms.
- C) On each additional story of the dwelling, including basements and habitable attics (finished) but not including crawl spaces, uninhabitable (unfinished) attics and uninhabitable (unfinished) attic- stories. In dwellings or dwelling units with split levels **and** without an intervening door between the adjacent levels, a smoke alarm installed on the upper level shall suffice for the adjacent lower level provided that the lower level is less than one full story below the upper level.
- D) If the existing smoke alarm is past the manufacturer's expiration date.

Not less than one properly functioning smoke alarm shall be present on each level of a weatherized dwelling. Devices shall be equipped with a 10-year lithium ion battery. Existing smoke alarms that are functioning properly and have not passed the manufacturer's expiration date at the time of the initial audit shall not be replaced.

Excepting instances where the Installation Standards shall conflict with manufacturer specifications or local code requirements, smoke alarms shall be installed at the optimal height as specified by the device manufacturer.

Weatherization service providers shall ensure that clients are well educated on the operation of any smoke alarm installed as well as on appropriate safety precautions to take, should an alarm occur.

5640 Electrical Hazards

A) Knob and Tube Wiring

Knob and tube wiring present in a weatherization-eligible dwelling shall be inspected by a licensed electrician prior to any weatherization work being performed in the affected area. Actions required to ensure code compliance, as well as occupant and weatherization personnel safety when working in areas with existing knob and tube wiring, may include full or partial replacement.

A licensed electrician shall inspect each dwelling component (attic, walls, and floor) where knob and tube wiring is present and shall document in writing the condition of the wiring observed. The electrician shall further make a determination certifying any action required in order for weatherization work (including insulation) to safely proceed. If a licensed electrician determines, based on conditions observed or applicable local code requirements, that the knob and tube wiring or any portion thereof must be replaced, agency must replace the wiring using available health and safety funds or other leveraging funds. If there are insufficient funds available to do so, the dwelling must be deferred until wiring can be replaced.

Copies of electrical inspections and certifications shall be provided to the property owner, be posted at the jobsite during weatherization, and documented in the client file.

B) Junction Boxes

Electrical connections throughout the weatherized dwelling, where exposed, shall be placed inside covered, code compliant, electrical junction boxes. The location of junction boxes shall be flagged when concealed beneath insulation or other weatherization materials or measures.

C) Aluminum Wiring

Dwellings constructed between 1965 and 1973 must be inspected for the presence of single strand aluminum wire. Aluminum wiring can combine with the oxygen in the air and form a coating on the wire that resists the flow of electricity. This resistance can cause the wires to overheat which may lead to a fire. Aluminum wiring can be identified in the following ways:

1. The color of aluminum (whitish in color);
2. Wiring-device binding terminals are CO/ALR, which stands for "copper/aluminum revised."; or
3. "Aluminum" or the initials "AL" are printed in embossed letters the plastic wire jacket.

If a licensed electrician determines that aluminum wiring is present, it shall be either replaced or repaired if insulation shall be installed. Deferral of a dwelling based solely on the presence of aluminum wiring shall not be allowed. Aluminum wiring may be addressed in the following ways:

1. Complete replacement with copper wire
2. Wiring repair - method of repair using Alumiconn or other UL approved connectors to transition from aluminum to copper wire in junction boxes is allowed. A licensed electrician must do the installation of these connectors. This a more cost-effective solution than complete replacement with copper wire.

Twist-on Connectors and/or CO/ALR switch replacements **are not** acceptable repair procedures. If repair or replacement of the wiring is cost prohibitive based on applicable health and safety expenditure guidelines and resources available, no insulation shall be installed in the areas where the aluminum wiring is present; however, air sealing and related work may still be performed.

5650 Materials Containing Asbestos

Asbestos is the name given to a naturally occurring group of minerals composed of tiny, easily inhaled fibers. Many common building materials, particularly those installed before the late 1970's, may contain asbestos. See chart below. Weatherization work may disturb building materials containing asbestos. Asbestos disturbance is defined as any activity which can result in the production of dust containing asbestos (friable asbestos) which may contaminate a structure. This includes drilling into asbestos or breaking wall floor or ceiling tiles containing asbestos while attempting to remove them. See section 5410 regarding asbestos and blower door diagnostics.

List of Suspect Asbestos Containing Materials	
Cement Pipes	Pipe Insulation (corrugated air-cell, block, etc.)
Cement Wallboard	HVAC Duct Insulation
Cement Siding	Boiler Insulation
Asphalt Floor Tile	Vinyl Wall Coverings
Vinyl Floor Tile	Ductwork Flexible Fabric Connections
Vinyl Sheet Flooring	Spackling Compounds
Flooring Backing	Joint Compounds
Construction Mastics (floor tile, carpet, ceiling tile, etc.)	Heating and Electrical Ducts
Acoustical Plaster	Electrical Panel Partitions
Decorative Plaster	High Temperature Gaskets
Textured Paints/Coatings	Electric Wiring Insulation
Packing Materials (for wall/floor penetrations)	Roofing Shingles
Spray-Applied Insulation	Roofing Felt
Vermiculite Blown-in Insulation	Base Flashing
Wallboard	Caulking/Putties
Taping Compounds (thermal)	Adhesives

Weatherization service providers shall be responsible for ensuring weatherization personnel, including subcontractor staff, possess adequate training and knowledge to enable them to properly identify asbestos encountered during initial dwelling audits and appropriately handle suspected asbestos containing materials (ACM). Weatherization personnel shall be required to successfully complete Occupational Safety and Health Administration's Asbestos Operations and Maintenance 16-hour course. In order to maintain compliance, an 8-hour refresher course must be taken every fiscal year.

Where asbestos is suspected, weatherization service providers shall ensure that all weatherization program services subsequently provided comply with applicable state regulations as specified by the North Carolina Asbestos Hazard Management Program (AHMP) administered by the Health Hazards Control Unit (HHCU) and applicable local codes. Where the AHMP regulations and applicable local codes conflict, the more stringent standard shall govern. The AHMP shall be consulted for information on the management of asbestos-containing materials and can be reached at (919) 707-5950 or <http://www.epi.state.nc.us/epi/asbestos/ahmp.html>.

If a dwelling is deferred due to excessive amounts of asbestos and client conducts asbestos remediation, they must supply NC WAP with AHERA certified professional documentation before weatherization services can begin.

Asbestos measures undertaken in compliance with state and local regulations shall be limited in scope. Asbestos testing, encapsulation, or removal activities shall be restricted to only the scale or scope required to provide for safe installation of weatherization measures. For example, removal of a limited portion of exterior siding material to allow for safe installation of a properly vented range hood exhaust fan shall be allowed. Removal of the exterior siding material from an entire dwelling shall not be allowed. The scope of allowable asbestos

management measures shall, additionally, not exceed the following limits:

- A) Siding/Ceiling/Wall Coverings – removal and replacement of materials where performed by an appropriately trained Operations and Maintenance worker or Asbestos Hazard Emergency Response Act of 1986 (AHERA) certified asbestos control professional*
- B) Vermiculite – testing and encapsulation where *performed* by an appropriately trained or AHERA certified asbestos control professional. Removal shall not be allowed. Blower door testing is discouraged. Where performed, pressurization rather than depressurization shall be mandated*
- C) Ducts/Pipes/Furnaces/Other – testing, encapsulation, or removal is allowable where performed by an AHERA certified asbestos control professional. *

*Material categories specified in items A-C of this section shall be treated as containing asbestos unless testing conclusively determines otherwise.

5660 Lead Dust Exposure

Common construction-related activities including, but not limited to, sanding, cutting, and demolition can create hazardous lead dust and chips by disturbing lead-based paint, which can be harmful to adults and children.

To reduce potential lead exposure risks, organizations performing renovation, repair, and painting projects that disturb lead-based paint in site-built dwellings built before 1978 shall be certified and shall follow specific work practices to prevent lead contamination.

A) Renovate Right

Weatherization service providers shall be responsible for compliance with the Environmental Protection Agency's (EPA) Lead Renovation, Repair and Painting (RRP) Rule; "Lead Hazard Information Pamphlet"; Notice of Availability; Final Rule, and with the requirements of the EPA's "Renovate Right: Important Lead Hazard Information for Families, Child Care Providers, & Schools" publication.

All site-built dwellings built prior to 1978 can be *assumed* to contain lead-based paint and require compliance with lead-safe work practices wherever weatherization measures with the potential to disturb lead-based paint shall be performed in such dwellings. Please note that *Deminimus* lead levels shall not be recognized. Site built dwellings may be tested for lead-based paint using one of two readily available EPA recognized RRP compliant test kits.

1. **3M™ LeadCheck™** - The EPA recognizes that the 3M™ LeadCheck™ lead test kit can reliably determine that regulated lead-based paint is not present on wood, ferrous metal (alloys that contain iron), or drywall and plaster surfaces.
2. **D-Lead®**. The EPA recognizes that the D-Lead® paint test kit can reliably determine that regulated lead-based paint is not present on wood, ferrous metal (alloys that contain iron), or drywall and plaster surfaces.

Weatherization service providers shall further be responsible for complying with mandatory documentation requirements for lead-safe work practices including, but not limited to, photographic documentation of jobsite and containment set up, waste disposal, a listing of materials used and measures performed, and identification of the certified lead renovator assigned to the job. Clean up procedures and documentation are required when using test kits.

B) Lead-Safe Weatherization

Lead-safe weatherization (LSW) is a set of protocols based on federal EPA and Occupational Safety and Health Administration (OSHA) regulations, applied when disturbing surfaces that may contain lead-based paint, and is intended to reduce and control the amount of lead dust and paint chips generated. LSW shall apply to all weatherization services providers administering the WAP and specific training shall be required.

While LSW should not be confused with the EPA's RRP Rule, for the purposes of compliance with the Installation Standards compliance with the RRP Rule, any additional NC WAP guidance, and local codes shall constitute compliance with LSW protocols.

5670 Radon Gas

Radon is a naturally occurring, colorless, odorless, tasteless, cancer-causing, radioactive gas found throughout the United States and can permeate the walls of any building type. Radon can only be confirmed by testing, which is generally inexpensive and noninvasive.

The EPA is charged with identifying areas of the United States with an increased potential for elevated indoor radon levels, and small portions of Western and Central North Carolina have been designated as "Radon Risk Areas". Weatherization service providers shall consult the EPA's website at: <https://www.epa.gov/radon/state-maps-radon-zones>

Allowable radon safety measures include testing, client education, and compliant vapor barrier installation in NC counties designated as zone 1 and 2 areas:

- A) Red {zone 1} - High Potential Radon Risk Area (*testing recommended*)
- B) Orange {zone 2} - Moderate Potential Radon Risk Area (*testing allowable*).



Weatherization service providers serving radon risk areas shall be responsible for educating clients on the potential presence of radon, associated health conditions, results from testing performed on the dwelling in writing to client, and living conditions that may contribute to higher radon concentrations. Clients in zones 1 or 2 must be provided with a Radon informed consent document prior to weatherization services being implemented.

5700 Mold and Moisture Remediation

Mold and mildew can pose serious potential health hazards for dwelling occupants. Weatherization service providers shall be responsible for ensuring steps are taken to alleviate moisture problems wherever feasible. All weatherization-eligible dwellings shall be inspected at the time of initial audit to determine that only minor moisture damage or mold growth, if any, is present. Where severe mold or moisture problems exist, the dwelling shall be deferred, and client notified in writing, until such time as the conditions can be corrected.

Visual assessment as well as diagnostics techniques such as the use of moisture meters shall be recommended both at the time of the initial audit and again during the final inspection. Mold testing shall not be allowed.

5710 Mold and Moisture Treatment Limitations

Where existing mold growth is determined to affect greater than 10 ft.² of surface area within a dwelling interior, crawl space, or attic, the dwelling shall be placed in deferral status and no weatherization program services shall be provided. Where areas of 10 ft.² or fewer exist and treating the mold is necessary in order to weatherize the home and to ensure the long-term stability and durability of measures, the affected area shall be treated prior to proceeding with any subsequent weatherization work.

Every individual remaining in the work area during treatment shall be equipped with a minimum N-95 respirator, leak-proof eye protection, and protective gloves and clothing. The work area shall be well ventilated and the mold-affected area shall be scrubbed clean using a brush, water, and a household detergent. Exhaust venting for clothes dryers shall be installed or repaired as needed to ensure that warm, moist air exhausted during the drying cycle is properly vented to the outdoors in every dwelling weatherized.

5720 Dryer Exhaust Venting

Dryer exhaust venting shall:

- A) Move moisture beyond the perimeter of the dwelling (crawl space, basement, other). *
- B) Consist of transitional duct of flexible metal inside the conditioned area only that is no more than 8 linear ft.
- C) Consist of rigid metal pipe which must be insulated to a minimum of R-8 outside the conditioned area in which the dryer is located.
- D) Be as straight as possible and span the minimum length required to exit the exterior of the dwelling, but shall never exceed 35 ft. in equivalent length.
- E) Be properly supported.
- F) Be fitted with an outdoor hood and back flow damper and must not contain a pest screen.
- G) Not contain more than two total elbows (each 90-degree elbow shall count as 5 ft. of run length for a 4 in. radius duct and shall count for 1 ft. 9 in. for a 6 in. radius duct).
- H) Not consist of sections secured using screws.

***In cases where venting dryer to the dwelling exterior is not possible, contact NC WAP prior to deferral of the dwelling**

Exceptions may be made on a case-by-case basis only with NC WAP approval using an indoor dryer vent kit.

5720 Dryer Exhaust Venting

Dryer Exhaust Venting Exiting Through Exterior Wall Diagram

Dryer exhaust venting exiting the dwelling through crawl space vents shall pass completely through the vent opening, be fitted with a draft hood and backflow damper, and any excess space remaining at the opening shall be filled with a rigid sheet-good and sealed to prevent moisture from blowing back into the crawl space.

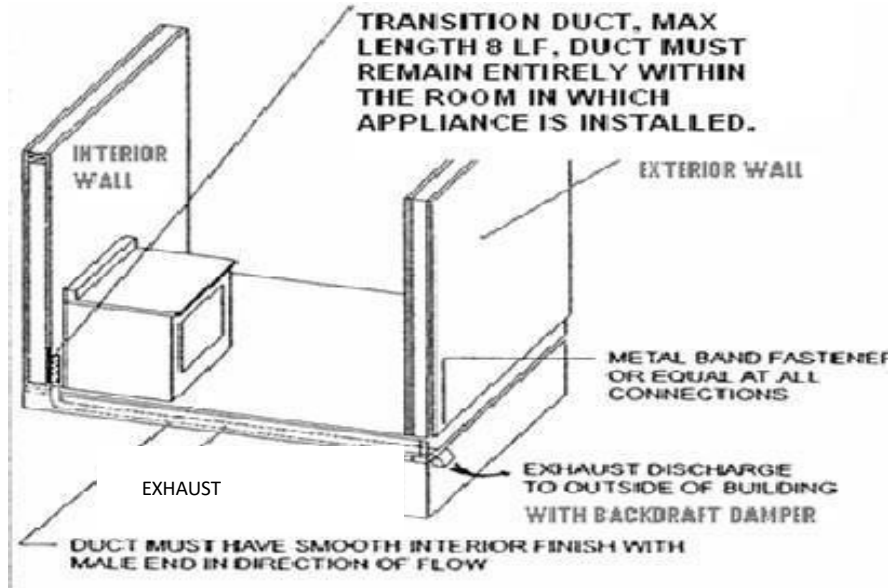

5730 Vapor Barriers

A continuous vapor barrier shall be installed in all enclosed, accessible, crawl spaces beneath conditioned space to prevent the diffusion of soil moisture into the dwelling or building materials. Vapor barriers shall not be installed under porches. Vapor barriers may be installed prior to floor air sealing and floor insulation. However, the vapor barriers must be left clean. Vapor barriers installed shall:

- A) Consist of not less than a 6-mil polyethylene sheet-material.
- B) Be opaque or non-translucent to decrease UV light transmittance that may promote material-deteriorating conditions beneath the barrier.
- C) Extend up the crawl space walls and piers not less than 6 in. but not more than 12 in., unless site conditions create a need to go higher.
- D) not come in contact with non-treated structural wood.
- E) Be continuous with reverse or upslope lapping seams of not less than 12 in.

5740 Moisture Diversion

Major drainage issues are beyond the scope of WAP services. Minor repair or installation of gutters, downspouts, drainage extensions, and/or flashing to divert moisture away from the foundation of a weatherized dwelling, as well as corrections to the grade of the landscape and installing trenches shall be allowed on a limited case-by-case basis.

Weatherization service providers shall be responsible for ensuring the use of weatherization program resources to correct drainage-related issues is justified and well documented. A lack of compelling evidence justifying the need for drainage-related work may result in expenditures for such work being disallowed.

5800 Indoor Air Quality and ASHRAE 62.2-2016

The American Society of Heating, Refrigerating and Air-Conditioning Engineers (ASHRAE) is an international organization with the mission of advancing heating, ventilation, air conditioning and refrigeration.

The American National Standards Institute (ANSI)/ASHRAE Standard 62.2-2016, *Ventilation and Acceptable Indoor Air Quality in Low-Rise Residential Buildings*, is the only nationally recognized IAQ standard developed solely for residences. It defines the roles of, and minimum requirements for mechanical and natural ventilation systems and the building envelope intended to provide acceptable IAQ in low-rise residential buildings. REDCALC is strongly recommended as the primary tool for ASHRAE calculations. This tool can be found at:

<http://www.residentialenergydynamics.com/REDCalcFree/Tools/ASHRAE6222016>.

All weatherized dwellings shall be supplied with adequate whole house mechanical ventilation in compliance with ASHRAE Standard 62.2-2016 (ASHRAE 62.2). Weatherization service providers shall be responsible for ensuring that a properly trained member of weatherization personnel or management determines the accurate calculation of the required rate of ventilation per dwelling for every dwelling weatherized.

5810 Ventilation Device Categories

Devices installed to achieve compliant mechanical exhaust ventilation levels shall include a combination of intermittent whole house ventilation (WHV) and local exhaust ventilation (LEV) fans. An LEV fan may be used to help achieve compliant WHV where the LEV is rated for use with a timer and is under 1 sone. Regardless of fan condition, all exhaust appliances must be equipped with a working damper to prevent air leakage.

This table assumes no elbows. Deduct 15 ft. of allowable duct length for each turn, elbow, or fitting.
 NL – no limit on duct length of this size
 X – not allowed
 w.c. – water column

5820 Ventilation Evaluation and Implementation

Upon completion of all cost-effective air sealing measures, all fans present shall be metered and the need for additional ventilation, if any, shall be determined using applicable diagnostic standards for calculating adequate WHV. Where the need for whole house intermittent ventilation exists, *Category B. Fan timers* shall be set as needed to provide the required airflow using the ASHRAE 62.2 calculation.

Where a functioning fan existing in a kitchen with an electric stove is metered and determined to be performing at less than 100 CFM, efforts shall be made to correct deficiencies in the installation of the fan and venting to increase the flow. Where existing fan or venting cannot be repaired to achieve airflow of at least 100 CFM, such fans may be replaced with *Category A. Fans*. Where a kitchen is missing a fan and it is not feasible to either correct an underperforming fan or install a *Category A. Fan*, the amount of airflow deficiency shall be added to the *Category B. Fan* whole house runtime.

Where functioning fans existing in second or third full bathrooms are metered and determined to be performing at less than 50 CFM, efforts shall be made to correct deficiencies in the installation of the fan and venting to increase the flow. Where existing fans or venting cannot be repaired to achieve airflow of at least 50 CFM, such fans may be replaced with *Category C. Fans*. Where a bath is missing a fan, or it is not feasible to either correct the underperforming fan or install a *Category C. Fan*, the amount of airflow deficient shall be added to the *Category B. Fan* whole house runtime.

To the extent practical, an existing noncompliant fan/light combination shall be replaced with compliant fan/light combination. Fan/light combination devices shall be IC-rated. Devices that specifically include heat as a feature shall not be allowed. Installation of a compliant fan alongside an existing heat/light combination device shall NOT be allowed as it could be a fire hazard if insulated over. If client is determined to keep the existing fan with heating, the dwelling must be deferred.

Mechanical exhaust ventilation fans installed shall be installed per manufacturer specifications and with electrical connections performed by a licensed electrician, as required by local, county, or state code. Fan controls shall be installed in the same room as the fan and fans rated for continuous operation shall be controlled by a dedicated switch. Bathroom exhaust venting shall be insulated to a minimum R-8. Kitchen exhaust venting shall be made of a smooth metal duct but shall not be insulated. All fans existing after weatherization shall exhaust to the outdoors. Under **no** circumstances shall installation or repair of recirculating fans be allowed, regardless of location or fuel sources present.

The suspected presence of materials containing asbestos or lead in ceilings or exterior walls shall not constitute justification for failure to comply with ventilation standards. Asbestos Operations and Maintenance training and Lead Safe Weatherization shall be used and documented when suspected materials are present. The presence of a metal roof shall not constitute justification for failure to comply with this standard. Similarly, where moisture issues exist in areas of a dwelling not adequately served by mechanical ventilation as specified herein, weatherization service providers shall be responsible for identifying and addressing the need for additional intermittent or spot ventilation devices.

Weatherization service providers shall ensure that dwelling owners and occupants are educated on the rationale and requirement to provide adequate mechanical exhaust ventilation dwellings at the outset of the job, as well as proper operation and maintenance of all devices present. Documentation of actions taken to comply with this standard, including specification data for each fan installed, shall be maintained in the job file.

6000 Diagnostic Testing Procedures

Dwelling-specific diagnostic testing shall be conducted on every dwelling weatherized, both at the time of initial audit and as mandated thereafter.

Weatherization service providers shall ensure that weatherization field personnel including, but not limited to, auditors, weatherization installers, inspectors, and subcontractors possess appropriate equipment and training to properly perform all required diagnostic testing.

Initial, interim, and final diagnostic tests shall be conducted at specified times during the weatherization process. Documentation of test types performed, test readings, and the identity of the individuals performing tests shall be maintained in the job file.

Diagnostic test types and guidelines listed herein shall not be considered exhaustive. Diagnostic procedures not listed herein shall be performed where required to maximize the potential benefits of energy efficiency measures installed or to maintain the health and safety of the dwelling and its occupants.

6100 Pre-Diagnostic Inspections

Prior to conducting diagnostic testing, a full dwelling inspection shall be completed to identify and document pre- test dwelling conditions, including potential health and safety hazards. Appropriate diagnostic tests and testing methods shall then be determined and conducted based on the specific conditions observed within the dwelling.

Potentially hazardous dwelling conditions requiring special consideration and caution prior to conducting diagnostic testing include, but shall not be limited to, the presence of:

- A) Building materials suspected to contain friable asbestos, including vermiculite-based attic insulation
- B) Mold, excessive moisture issues, or biological hazards, including raw sewage
- C) Dwelling occupants with preexisting health conditions which testing may exacerbate.

Diagnostic testing shall cease or be postponed wherever dwelling conditions that may pose an immediate safety hazard are identified or where conditions observed necessitate that the dwelling be placed on deferral status.

6200 Blower Door Diagnostics and Blower Door Guided Air Sealing

Blower door diagnostics shall be performed using a blower door fan to create a pressure difference between two spaces for the purposes of diagnosing air leakage or connectivity between the spaces. The blower door (used in concert with a digital manometer or pressure and flow gauge) is a building performance diagnostic tool used for the purpose of identifying air leakage or infiltration. Blower-door-guided air sealing and related blower door diagnostics shall be performed using either the pressurization or the depressurization test set-up.

Blower-door-induced depressurization has the ability to draw contaminants into the living space; therefore, it is vital that a complete inspection of the dwelling be performed prior to conducting blower door testing. Identification of specific dwelling conditions may necessitate use of pressurization testing versus depressurization testing to avoid exposing the dwelling and occupants to potential adverse effects resulting from blower door testing including, but not limited to, conditions listed in section 6100 of this Chapter.

Blower door testing shall be performed based on a sustained 50 Pascal (Pa) pressure difference in the dwelling with reference to (WRT) the outdoors, measured using a digital manometer. Airflow readings measured in CFM shall be adjusted as needed where a 50 Pa. pressure difference cannot be established by using either the “Can’t Reach Fifty” multiplier or use a manometer that makes this conversion automatically.

Testing procedures for pressurization testing require some alterations to the test set up in addition to reversing the direction of the airflow per manufacturer instructions for the particular device model in use. Exhaust vent dampers (bathroom, kitchen, and dryer) must be temporarily blocked to insure accurate readings.

6220 Zonal Pressure Diagnostics

Zonal Pressure Diagnostics (ZPD) shall be performed at intersections between the intentionally conditioned main body of a dwelling and areas where unintentional connections with unconditioned spaces most often occur including, but not limited to, areas such as:

- A) Garages
- B) Basements
- C) Attics
- D) Crawlspace
- E) Additions
- F) Dropped soffits
- G) Interior walls (using pressure pan to identify top and/or bottom plate leakage).

Test holes or penetrations drilled into the dwelling shell to perform ZPD shall be located in inconspicuous areas such as closets, utility rooms, or other areas where holes are least likely to be visible post-work. Alternatively, existing holes may be used for ZPD, include crawl space hatches vents, and basement doors. Penetrations made in ceilings or floors shall be located as close to the perimeter of the dwelling as possible. For final testing, holes shall be patched with a caulking material similar in color to the drilled or cut surface.

Whenever possible, “add a hole” ZPD method shall be used to increase accurate zonal readings, especially house to attic and house to garage zonal testing.

Detailed work orders should include instructions when NOT TO air seal if pressure diagnostics eliminate the need for air sealing in a certain unconditioned zone.

6230 Duct-Tightness Testing

Duct-tightness testing shall be conducted in every weatherized dwelling where a ducted distribution system is present. Distribution systems shall be visually inspected, including operation of the associated air handler to identify leakage in the system, in addition to conducting duct-tightness testing using the blower door and pressure pan/duct mask method. Pressure readings shall be recorded for all supply and return registers.

In dwellings in which the Priority List shall be used, accessible portions of active duct distribution systems shall be sealed to a tightness of 1.0 Pa or below, as measured with a pressure pan and the blower door depressurizing the dwelling to 50 Pa and ducts measured WRT the dwelling. When conducting duct tightness testing if the duct location is less than 45 Pa, a pressure pan multiplier shall be used to compensate for the difference in testing conditions. Where compliant test pressures of 1.0 Pa are not achieved, justification for the failure shall be documented in the job file.

Abandoned duct distribution systems shall be closed off from the dwelling and sealed to restrict airflow between conditioned and unconditioned space with the goal of achieving a pressure difference, with the blower door running, between the two spaces to as close to 50 Pa as possible.

In dwellings in which the NEAT portion of the WA shall be used, duct leakage to the outside shall be no more than 8 CFM per 100 sq. ft. of conditioned floor area. This is measured with a duct leakage tester ("ductblaster) depressurizing the duct system to 25 Pa WRT the outdoors and a blower door simultaneously depressurizing the dwelling to 25 Pa WRT the outdoors. Total duct leakage shall be no more 12 CFM per 100 sq. ft. of conditioned floor area. This is measured with a duct blower depressurizing the duct system to 25 Pa WRT the outside. Where compliant test pressures of 8 CFM and 12 CFM per 100 sq. ft., respectively, of conditioned floor area are not achieved, justification for the failure shall be documented in the job file.

In dwellings in which the NEAT portion of the WA assistant shall be used, it is acceptable to first test ducts using the pressure pan method. If initial duct readings are below 1.0 Pascals for each duct, it is acceptable to waive testing with the ductblaster and the ducts do not have to be evaluated in the NEAT computer audit. This must be well documented in the REAT.

6300 Duct Induced Room Pressure Testing

Room-to-room duct-induced pressure testing shall be conducted in every weatherized dwelling where an active ducted distribution system is present. Room-to-room pressure readings shall not deviate more than plus or minus 3.0 Pa WRT the inside of the dwelling. Where induced pressure readings exceed 3.0 Pa WRT the inside of the dwelling, one or more of the following corrective measures shall be required:

- A) Undercutting doors
- B) Adding pass-through vents above doors
- C) Adding jump-over ducts between rooms
- D) Adding return air to the room (performed only by licensed HVAC technicians on a limited case-by-case basis).

It is not required to provide room pressure relief to bathrooms, or laundry/utility rooms with louvered doors. If room pressure relief is provided to a bathroom, only option A is allowed. Where dwelling owners refuse to authorize installation of room pressure relief, documentation of this refusal signed by the dwelling owner shall be maintained in the job file.

Undercutting hollow core doors without the use of an inset door vent shall not be allowed due to compromising the integrity of the door.

6400 Exhaust Fan Flow Meter Diagnostics

All functioning exhaust fans located in weatherized dwellings shall be metered during the initial audit and final inspection using an approved fan-exhaust metering device. Existing re-circulating fans may either be corrected to exhaust to the outdoors or shall be replaced as part of the weatherization process and therefore need not be metered at the time of audit.

Where existing exhaust fans are determined to be providing less than the required minimum CFM, the following corrective measures shall be performed:

- A) Fan shall be checked to ensure it is installed per manufacture specifications and corrected where installed incorrectly.
- B) Fan shall be cleaned to ensure it is free of debris or obstructions.
- C) Fan exhaust venting shall be repaired or replaced to achieve the shortest and straightest run possible.
- D) Exhaust venting must be at least 6" in diameter and insulated to a minimum of R-4; HVAC flex duct is usually the easiest option to accomplish this.

During the final inspection all fans present shall be re-metered and the need for intermittent ventilation, if any, shall be determined. Where the need for ventilation exists, a timer shall be set as needed to provide the required CFM of additional airflow based on specifications provided in section 5800.

6500 Combustion Analysis

Combustion analysis shall be performed in every weatherized dwelling where fuel-fired or combustion appliances are present. Where a compliant, nonfunctioning, fuel-fired unit exists and will remain in the dwelling post-weatherization, combustion analysis shall be performed as soon as the unit is made functional. Applicable combustion analysis inspection and diagnostic requirements shall include *at minimum* the following procedures where applicable:

- A) Fuel Supply Inspection—the fuel supply for all liquid or gas-fired appliances shall be tested for leaks and addressed as needed prior to additional system testing.
- B) Combustion Vent Pipe—combustion venting systems shall be inspected to ensure systems are suitable for the heating unit type and location where installed. Venting shall be properly sized, material types shall be appropriate, vent pipe condition shall be satisfactory, clearances shall meet applicable codes, and the vent system shall be unobstructed.
- C) Combustion Air Supply—adequate combustion air supply shall be provided for all combustion appliances located in weatherized dwellings as mandated by the Installation Standards and National Fire Protection Association (NFPA) code. Combustion supply air shall be considered adequate when the volume of the space used for combustion air is at least 50 cubic feet per 1000 Btu's of the appliance(s) rated input. Where additional combustion air is required, the following minimum combustion air supply limitations shall apply:
 1. Where all combustion air is obtained from the house, 1 sq. in. of net free area per 1,000 Btu of input shall be allowed.
 2. Where all combustion air is obtained from the outdoors via a vertical pipe, 1 sq. in. of net free area per 4,000 Btu of input shall be allowed.
 3. Where all combustion air is obtained from the outdoors via a horizontal pipe, 1 sq. in. of net free area per 2,000 Btu of input shall be allowed.

Combustion air shall be provided using a high/low orientation where one source is located 12 in. from the floor and another source is located 12 in. from the ceiling. Obtaining *additional* combustion air from both the living space and from the outdoors shall be prohibited.

Combustion Appliance Zone (CAZ) testing shall be performed on all functioning, fuel-fired vented appliance systems, regardless of location, during the initial audit, the final inspection, and as needed throughout the weatherization process. Worst-case CAZ **depressurization** limits are shown below:

CAZ Depressurization Limits	
Venting Conditions	Limits (Pascals)
Orphan natural draft water heater (including outside chimneys)	-2
Natural draft boiler or furnace commonly vented with water heater	-3
Natural draft boiler or furnace with vent damper commonly vented with water heater	-5
Individual natural draft boiler or furnace	-5
Mechanically assisted draft boiler or furnace commonly vented with water heater	-15
Mechanically assisted draft boiler or furnace alone, or fan assisted DHW alone	-15
Exhaust chimney-top draft inducer (fan at chimney top); High static pressure flame retention head oil burner; Sealed combustion appliances	-50

For guidance and detailed instructions on proper combustions appliance zone and combustion testing, please refer to the Residential Energy Assessment Tool (REAT). BPI or other approved combustion testing worksheets may also be used.

Exception: Wood burning and lump coal units where no fuel is available during the cooling season shall be visually inspected to determine the condition of the following components - cracks in the heat exchanger, corrosion, improper venting, and clearance from combustibles.

D) Steady State Efficiency (SSE)—SSE testing shall be performed on all vented combustion heating systems to determine whether systems are functioning at or near the rated or peak efficiency for the particular unit type. SSE is tested in conjunction with CO or draft tests and is measured automatically using a combustion analyzer.

SSE readings recorded shall reflect the efficiency percentage for the unit under ideal conditions, or as measured once the system has been operating long enough to reach steady state. Steady state has typically been reached when stack temperatures increase by not more than 2 degrees Fahrenheit (°F) in 60 seconds. SSE test readings coupled with CO, Oxygen, and stack temperature readings may provide clues as to the cleaning or tuning needs for a heating unit.

HEATING UNIT/SYSTEM TYPE	COMMON STEADY STATE EFFICIENCY RANGES BY SYSTEM TYPE (%)*
High-Efficiency Condensing	85 - 95 %
Powered Boiler	75 - 85 %
Oil Burner System	70 - 85 %
Low-Efficiency Atmospheric	70 - 80 %
Vented Space Heater	50 - 80 %

*Rates shall be used for reference purposes only and shall not define "pass" or "fail" for any unit type.

- E) Carbon Monoxide Testing— ambient CO levels shall be monitored upon entering dwellings and throughout the testing period for all appliances to ensure safe CO levels are not exceeded. Ambient CO levels of 35 parts per million (ppm) or greater shall require immediate action to identify and correct the problem prior to resuming system testing. The maximum allowable post-work ambient CO levels in weatherized dwellings shall be 35 ppm.
- F) CO levels in undiluted flue gases shall be tested on all vented combustion appliances. Where CO levels in undiluted flue gasses are measured at 100 ppm or greater, immediate action shall be taken to identify and correct the deficiency prior to resuming testing.

CO levels shall be tested in association with all unvented combustion space heaters. Tests shall be conducted by holding the test probe at or near the unit while firing and shall be measured based on the 35 ppm maximum for ambient CO levels.

- G) Draft Testing—a worst-case draft test shall be conducted on all liquid or gas-fired appliances to ensure allowable draft pressures for the venting system can be sustained under worst-case conditions, enabling combustion gases to be safely exhausted from the dwelling.

Draft testing shall be performed on all functioning, fuel-fired vented appliance systems located in the shell (including attics, crawl spaces, and basements) of weatherized dwelling during the initial audit, the final inspection, and as needed throughout the weatherization process. When testing, there should be no spillage after 1 minute at worse case conditions. If appropriate draft (see Residential Energy Audit Tool Instructions for more information) is not established corrective action must be taken.

Outside Temperature (Degree F)	Minimum Draft Pressure Standard (Pa)
<10	-2.5
10-90	(T-out ÷ 40) -2.75
>90	-0.5

6510 Draft and Combustion Testing by System Type

- A) Sealed Combustion or Power Vented (90% +)—No draft measurement shall be required and no holes shall be drilled in flues for power vented or sealed combustion units. CO levels shall be measured at the exterior outlet of the flue where accessible. Where it is deemed unsafe to access termination points for testing due to the height of the roof, testing requirements shall be waived; but such situations shall be documented in the job file.
- B) Outdoor combustion package furnaces - CO levels shall be measured at the exterior outlet of the exhaust port. All gas package units, including new installations, **must be tested for CO levels.**
- C) Atmospheric or Natural Draft (70%)—Draft testing shall be conducted in the center of the longest straightest accessible section of the vent. Holes drilled in order to measure draft shall be drilled using a 5/16th drill bit. Post-testing, holes shall be plugged using a 3/8 in. stainless steel tap bolt and sealed with high-temperature 100% room temperature vulcanizing (RTV) silicone caulk. To ensure a tight seal, plug bolts shall be coated with high-temperature silicone prior to being placed. CO testing shall be conducted at the heat exchanger cell outlets in undiluted flue gases.

- D) Induced Draft (80%)—Draft testing shall be conducted in the center of the longest straightest accessible section of the vent. Holes drilled to measure draft and CO (single location for both tests) shall be drilled using a 5/16th drill bit. Post-testing, holes shall be plugged and sealed in the same manner as holes on atmospheric or natural draft devices.
- E) Water Heaters and Orphaned Water Heaters - Draft testing shall be conducted in the center of the longest straightest accessible section of the vent after the draft hood. Holes drilled in order to measure draft shall be drilled using a 5/16th drill bit. Post-testing, holes shall be plugged using a 3/8 in. stainless steel tap bolt and sealed with high-temperature 100% room temperature vulcanizing (RTV) silicone caulk. To ensure a tight seal, plug bolts shall be coated with high-temperature silicone prior to being placed. CO testing shall be conducted before the draft hood in undiluted flue gases.
- F) Oil Furnace (75-80+) - Draft testing shall be conducted in the center of the longest straightest accessible section of the vent, but before the barometric damper. SSE shall be measured and Oil furnaces with SSE less than 75% shall be evaluated for a flame retention head oil burner (FRHOB). FRHOB have motors that run faster (3450 rpm) than older oil burners (1725 rpm). When replacing an older burner with a FRHOB, ensure the burner orifice is evaluated for resizing. Type- L vent, which is stainless-steel inner pipe and galvanized-steel outer pipe, shall be used with oil furnaces.

Care shall be taken by weatherization personnel to ensure that holes drilled for testing purposes are as close to 5/16 in. in diameter as possible both for purposes of repeat testing and ease of plugging such holes using standard 3/8 in. stainless steel bolts. Care shall be taken to ensure that holes are plugged and sealed, particularly holes drilled through the inner liner of B- vent piping both for reasons of manufacturer warranty and local code compliance.

The American Gas Association Venting Categories		
	Negative Pressure Venting	Positive Pressure Venting
Non-condensing	I	III
	Combustion Efficiency	Combustion Efficiency
	83% or less	83% or less
	Flue Gas over 140°F	Flue Gas over 140°F
	Use standing venting: Masonry or Type B Vent	Use only pressured vent as specified by the manufacturer
Condensing	II	IV
	Combustion Efficiency	Combustion Efficiency
	Over 83%	Over 83%
	Flue Gas under 140°F	Flue Gas under 140°F
	Use only condensing service vent as specified by manufacturer	Use only pressurizable condensing service vent as specified by manufacturer

Common Heating Systems and Combustion Testing Locations

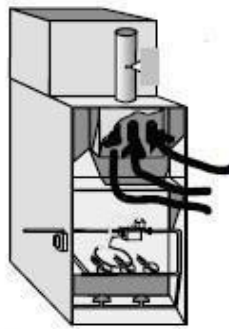

Atmospheric Furnace

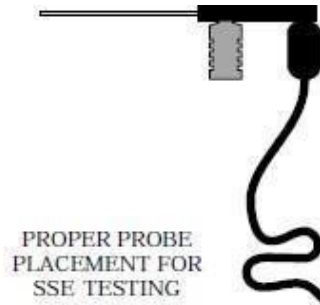

PROPER PROBE
PLACEMENT FOR
SSE TESTING

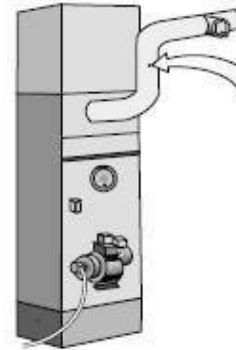

Fuel Oil Furnace

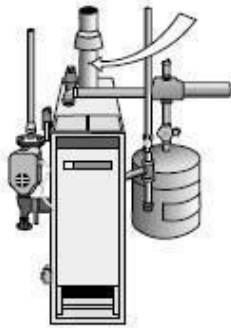

Atmospheric Boiler

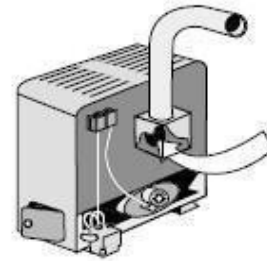

Space Heater

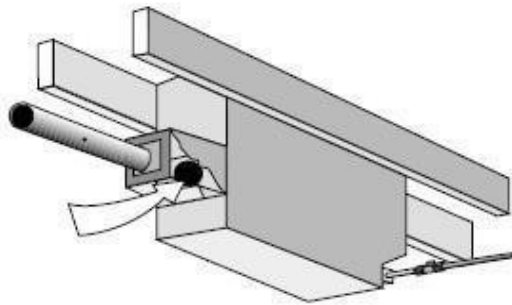

Floor Furnace

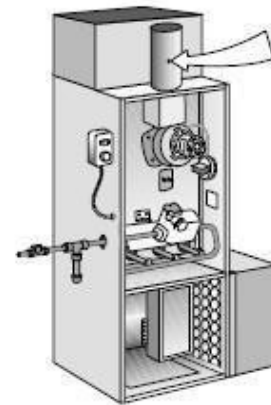

80+ Induced-draft Furnace

6520 Fuel-Fired Cooking Appliance Testing and Repair

Fuel-fired cooking appliances shall be visually inspected in the case of stove top burners, and “CO tested” in the case of oven burners, to ensure appliances are not emitting unsafe levels of CO. Where unacceptable CO levels are detected, servicing or repairing appliances shall be required. Under no circumstances shall cooking appliance replacement be allowed.

Maximum allowable CO levels for fuel-fired range-top and oven burners:

- A) Range-top burners - 25 ppm as measured, if inspector deems range top burners fail visual inspection.
- B) Oven burners - 100 ppm as measured or 400 ppm air-free.

Each range-top burner assembly shall be visually inspected by firing the burner and monitoring for any signs of flame discoloration, flame impingement, or irregular pattern. If any of these are evident, measurements shall be taken with the test probe located approximately 6 in. above each operating burner.

Where initial test readings are 25 ppm or greater as-measured, corrective actions shall include but not be limited to:

- A) Inspecting burners for obstructed ports
- B) Cleaning and tuning the appliance by a repair professional trained and certified to service the *brand* of appliance in use
- C) Retesting the burner CO levels post-cleaning
- D) Educating occupants on burner cleaning and maintenance procedures where applicable.

Fuel fired oven burner assemblies shall be tested. Testers shall ensure that all cooking utensils, protective pans, or aluminum foil are removed from the oven. Primary oven burners shall be fired on the highest baking-mode temperature setting. Broil-mode temperature settings *shall not* be used during oven testing; where present, separate broiler burner assemblies shall be excluded from testing.

After approximately ten minutes of operating time, test probes shall be inserted into oven exhaust vents at a depth that enables testing of the undiluted exhaust gases. CO levels customarily peak just after burner firing and then fall to a momentary plateau prior to the burners shutting down as part of the duty cycle. CO readings recorded shall be taken during this stable plateau.

Where initial test readings are 100 ppm or greater as-measured or 400 ppm air-free, corrective actions shall include but not be limited to:

- A) Identifying and removing obstructions in the air supply
- B) Servicing of the appliance by a repair professional trained for appliance in use
- C) Confirming burner is in alignment and leveling the entire appliance where applicable
- D) Educating occupants on how to clean the flame plate where applicable.

Where servicing or repair work is necessary and is determined to be unfeasible or cost-prohibitive, the dwelling shall be placed on deferral status until the hazard condition can be corrected.

6530 Fuel-Fired Clothes Dryer Testing and Repair

Fuel-fired clothes dryers shall be tested for proper operation including, but not limited to, gas leak testing, testing ambient CO levels in the room in which the dryer is located, and testing CO levels at the exhaust hood, which must terminate outside of the dwelling.

Where unacceptable CO levels are detected, servicing or repairing appliances shall be allowed. Where servicing or repair work is necessary and is determined to be unfeasible or cost-prohibitive, the dwelling shall be placed on deferral status until the hazard condition can be corrected. Under no circumstances shall clothes dryer replacement be allowed.

7000 Heating, Ventilating, and Cooling Systems

Improperly functioning HVAC systems often contribute to adverse conditions in low-income dwellings including, but not limited to, moisture and mold growth, CO poisoning, fire hazards, and increased heating and cooling expenses. Each of these serious potential conditions may be exacerbated by weatherization work where steps in the weatherization process are skipped or poorly performed, putting both the dwelling and the dwelling occupants at risk. Guidance issued in this section shall apply to HARRP.

7100 ACCA Standard 4

As substantial harm can result from failures to properly address heating, ventilating, and air conditioning (HVAC) systems in weatherized dwellings, NC WAP has adopted standards for inspecting, repairing, and replacing HVAC equipment that include employing the services of professional HVAC technicians licensed by the State of North Carolina.

In addition to compliance with the Installation Standards and applicable local codes, all HVAC-related services performed, whether by professional HVAC technicians or weatherization service providers, shall additionally comply with the ANSI/Air Conditioning Contractors of America (ACCA) Standard 4 and applicable local codes. The more stringent standard shall govern.

Under no circumstances shall the act of employing a licensed HVAC technician in any way diminish the responsibility of weatherization service providers as program administrators to ensure compliance with all applicable standards and guidance governing the identification, inspection, maintenance, repair, replacement, and safe operation of HVAC systems.

HVAC repairs, upgrades, or replacements performed in compliance with the standards listed herein shall be as energy-efficient for the client and as cost-effective for WAP as possible.

7200 Evaluate, Clean, and Tune Requirements

Every dwelling weatherized shall have all HVAC systems evaluated, cleaned, and tuned (ECT) by a licensed HVAC technician unless otherwise excepted herein. The ECT shall be performed only after completion of the dwelling audit. HVAC technicians must complete all applicable sections of the HVAC evaluation report and note whether unit passes or fails. If the unit fails, detailed notes justifying the required repairs or replacement must be included. Required repairs or replacements shall be complete prior to any subsequent weatherization work commencing. An ECT shall consist at a minimum of inspection, safety & efficiency testing, cleaning, and adjustment of all system components, fuel supply, piping, venting components, chimneys, flues, and all heating units present in the dwelling. ECT requirements shall extend to central air conditioning systems where applicable.

HVAC technicians performing ECTs shall hold at minimum a current Heating, Group 3, Class I or Class II license issued by the State of North Carolina. Possession of a Heating Group 1, Class I or Class II license is required for work on boilers or other steam systems. Weatherization service providers shall be responsible for ensuring that all HVAC technicians performing services are properly licensed, insured, and bonded (where applicable). HVAC contractor license status may be verified online by accessing the State Board of Examiners webpage located at: <http://www.nclicensing.org/OnlineReg.htm>.

Where dwellings rely on fuel-fired or combustion heating units (particularly wood burning stoves, fireplaces, and oil furnaces), evaluation of the venting components and associated chimneys or flues is critically important. In such instances the services of a chimney professional certified by the National Fireplace Institute (NFI) or Chimney Sweep Safety Institute of America (CFIA) may additionally be retained where the HVAC technician responsible for performing the ECT either lacks adequate knowledge of servicing fuel-fired venting components and chimneys, or where the ECT identifies deficiencies a chimney professional might be better trained and equipped to rectify. NFI certified Wood Burning and Pellet Burning Specialists may be located by accessing the NFI webpage at: <https://www.nficertified.org/industry/nfi-woodburning-specialist/> or <https://www.nficertified.org/industry/nfi-pellet-specialist/>. CFIA certified chimney sweeps may be located by accessing the CFIA webpage at: <http://www.csia.org/>.

HVAC technicians (and chimney sweeping professionals where applicable) shall complete the Heating, Ventilation, and Air Conditioning System Evaluation Report for every weatherized dwelling. Reports must fully document conditions observed during the evaluation including, but not limited to, diagnostic testing results, conditions observed through visual inspection, and suggested corrective actions for any deficiencies identified. A copy of the ECT Report and any supplemental data provided shall be maintained in the job file.

Exception: Evaluation by a licensed HVAC technician shall not be required where a dwelling relies solely on permanently installed electric space heaters (for example, hard-wired electric baseboard heaters) as the primary heat source and no fuel-fired supplemental heat sources are present. Supplemental heating systems (defined below) shall not be required to have an evaluation by a licensed HVAC technician. Evaluation and cleaning shall still be performed on such units, though the services may instead be performed by a qualified member of weatherization service provider staff in compliance with applicable standards listed herein.

Weatherization service providers shall be ultimately responsible for ensuring the compliance of all HVAC systems present in weatherized dwellings and shall therefore be required to provide detailed specifications, maintain detailed documentation, and thoroughly inspect all work performed by licensed HVAC technicians and related third-party professionals prior to accepting such services as complete.

7300 Mandatory Heat Provision Requirement

A PROPERLY FUNCTIONING, ADEQUATE, AND SAFE PRIMARY HEAT SOURCE SHALL BE PRESENT IN EVERY ELIGIBLE DWELLING PRIOR TO ANY WEATHERIZATION PROGRAM SERVICES (EXCEPTING THE INITIAL AUDIT AND THE ECT) BEING PROVIDED.

A properly functioning heat source is one that is functioning as intended by the manufacturer and is free from material defects in installation, maintenance, and operation. A properly functioning heating source should perform at or near the maximum rated efficiency for that unit. An adequate heat source is one that provides heat sufficient to warm the intentionally conditioned spaces within the dwelling to not less than 68°F at an outside temperature of 20°F. A safe heat source is one that when used as intended poses no risk of adverse effects to the dwelling or to the client.

7310 Definition of Primary Heat Source

Primary Heat Source – As all parts of the state experience at least 3400 heating degree hours per year, a primary heat source shall be required. The primary heat source shall be defined as one or more safe, permanently installed, properly functioning, central or space heating units and their associated fuel sources which together are capable of heating all intentionally conditioned spaces within the dwelling to not less than 68°F, where the outside temperature is 20°F or greater.

Where a weatherization-eligible dwelling initially lacks a system or systems which together comprise a compliant primary heat source as defined herein, weatherization service providers shall take necessary actions to establish a compliant primary heat source for the dwelling, using existing fuel sources, prior to any subsequent weatherization work commencing.

If Baseboard Heat is the primary heating system in a dwelling, another energy efficient hvac system may be installed, as listed in (A) or (B) below. Do not remove the Baseboard Heating system unless it has been deemed to be a safety hazard to the occupants. This guidance is due to the inefficient, high operations costs of Baseboard Heating systems.

At the time of the initial audit, weatherization service providers shall document the type and condition of all heating and cooling systems present in the dwelling pre-weatherization. When the weatherization job is complete, the type and condition of all heating and cooling systems shall again be documented, recording data for systems at current post-weatherization status. For federal reporting purposes (such as AR4CA) where only a single primary fuel source may be recorded, the recorded primary fuel source shall be deemed the post-weatherization source that generates the greatest percentage of heat for the dwelling, (i.e., the fuel source that generates 51% or more of the total heat where two contributing systems fueled by different fuel sources are present).

Allowable unit types that may contribute to the mandatory provision of a compliant primary heat source shall include:

- A) Electric
 1. central heat pumps
 2. ductless (mini-split) heat pumps
 3. window heat pumps
 4. packaged terminal air conditioners (PTAC) and packaged terminal heat pumps (PTHP)
 5. central electric resistance furnaces (repairs only, replacements not allowed)
 6. existing hard-wired space heaters, including wall, and ceiling units (repairs only, replacements not allowed)
- B) Fuel-Fired
 1. central package systems
 2. central split systems
 3. vented or sealed combustion space heaters
 4. vented atmospheric space heaters
 5. vented solid-fuel burning stoves (wood, pellet, coal)
 6. steam, hot water, or boiler units (prior approval required)
 7. gravity warm-air furnaces (repairs only, replacements not allowed)
 8. vented fireplaces

Unvented fuel-fired space heaters, as well as portable heating units, regardless of fuel source, *shall never* constitute or contribute to a primary heat source.

Portable heating units are those designed for easy regular movement from room to room. Unit types listed as allowable contributors to a primary heat source may be considered moveable under certain conditions but, shall not be considered portable.

7320 Definition of Supplemental Heat Source

An audit, an ECT, and any work required to establish a primary heat source as defined herein shall be completed prior to any additional weatherization work being performed.

Supplemental Heat Source – The supplemental heat source shall be defined as one or more safe, properly functioning, portable or permanently installed space heating units and their associated fuel sources which provide additional heat to areas within the dwelling on a temporary or intermittent basis above and beyond the heat provided by the primary heat source.

UL Listed portable electric space heaters may remain in the dwelling during and post-weatherization where such units have been properly inspected and deemed to be operating safely.

A limited variety of unvented fuel-fired space heaters may remain in a dwelling during and after weatherization where such units have been properly inspected and deemed to be operating safely and where the unit complies with the minimum standards for unvented fuel-fired space heaters listed herein.

Where a compliant system serving as a supplemental heat source is evaluated and determined to be unsafe, the system may be repaired to the extent allowable or shall be surrendered by the owner and permanently removed from the dwelling and decommissioned prior to proceeding with weatherization.

7330 Unvented Fuel-Fired Space Heaters

Any unvented (also referred to as vent-less or vent-free) fuel-fired space heater remaining in a weatherized dwelling during or post-weatherization to serve as a compliant supplemental heat source shall:

- A) Not have an input rating in excess of 40,000 Btu/hr. regardless of location (oxygen depletion sensors are not required unless located in bathroom or bedroom);
- B) Not be located in or utility rooms, closets, or similarly restricted spaces.

Any single UL Listed, unvented, fuel-fired space heater remaining in a bathroom or a bedroom where allowed by local code shall:

- A) Not have an input rating in excess of 6,000 Btu/hr. in a bathroom or 10,000 Btu/hr. in a bedroom;
- B) Be equipped with an oxygen depletion sensing safety shut-off system;
- C) Have an adequate supply of combustion air based on the volume of the room where located;
- D) Be wall-mounted or permanently installed in a solid-fuel burning fireplace.

Any unvented fuel-fired space heater that does not comply with the standards listed herein shall be surrendered by the owner, permanently removed from the dwelling, and decommissioned prior to providing any subsequent weatherization program services.

Where unvented fuel-fired space heaters that do not comply with the standards listed herein exist in an otherwise weatherization-eligible dwelling, weatherization service providers shall be responsible for educating the client on the potential safety hazards associated with the operation of such units. Weatherization service providers shall obtain voluntary, written surrender authorization from the property owner to remove and permanently de-manufacture all such units prior to providing any additional weatherization program services.

Owners who decline to authorize removal of noncompliant unvented fuel-fired space heaters shall be notified in writing that the dwelling must be placed in deferral status until the potential safety hazard represented by the noncompliant space heater has been removed.

Total program expenditures associated with dwellings where unvented fuel-fired space heating units are present may be disallowed where weatherization service providers fail to ensure either that:

- A) Noncompliant space heating units are properly identified
- B) Steps taken to address noncompliant space heating units are properly documented
- C) Written surrender authorization is obtained from the dwelling owner and the unit removed
- D) The dwelling is placed in deferral status until such time as the noncompliant space heating unit is surrendered.

7340 Mandatory Deferral Due to Lack of Primary Heat Source

Where evaluation of a system contributing to the primary heat source for a dwelling determines that the system must be repaired or replaced in compliance with the Installation Standards and insufficient program resources exist to complete the required work, no subsequent weatherization services shall be performed, and the dwelling shall be placed on deferral status until such time as resources become available. Failure by weatherization service providers to ensure that only compliant primary and supplemental heat sources are present in weatherized dwellings may result in all program expenditures associated with weatherizing the dwelling being disallowed.

7400 Initial and Final Weatherization Heating, Ventilating, and Air Conditioning System Evaluation

Under no circumstances shall the act of employing a licensed HVAC technician in any way diminish the responsibility of weatherization service providers as program administrators to ensure compliance with all applicable standards and guidance governing the identification, inspection, maintenance, repair, replacement, and safe operation of all HVAC systems.

In addition to compliance with ACCA Standard 4 and local codes, certain general evaluation requirements shall apply to HVAC assessments performed as part of initial audits and final inspections, for both the purposes of identifying potential hazards at the earliest opportunity as well as in order to assess the dwelling conditions on which the work performed by HVAC technicians and other third-party subcontractors shall be predicated and judged.

Weatherization service providers shall be responsible for ensuring that all auditors and inspectors possess necessary training and equipment to enable them to accurately identify system type(s) and effectively perform type-specific preliminary evaluations as part of the initial audit/final inspection. Emphasis shall be placed on the ability of auditors to accurately identify and document heating system types existing pre-weatherization. Similar emphasis shall be placed on the ability of final inspectors to identify and document systems existing post-weatherization.

Weatherization personnel shall remain responsible for completing a variety of standard HVAC evaluation functions as mandated by initial audit and final inspection protocols or as necessitated by conditions present in a particular dwelling. Such inspection functions shall include, but shall not be limited to, identifying safety hazards that constitute emergency situations or that require repair work must be completed prior to proceeding with weatherization. Weatherization personnel shall at all times be responsible for documenting conditions observed and notifying dwelling occupants, as well as providing ongoing client education.

Weatherization HVAC system evaluation shall include, but not be limited to, functions outlined in Items 7410-7460 of this Section.

7410 System Maintenance

Where a forced air distribution system is used, filter(s) shall be installed or replaced and a 4-month supply of appropriately sized filters for each filter location shall be provided to the client. Filters provided shall meet manufacturer specifications based on the type of system present and for new installation of central systems, must be at least MERV 6. Replacement of return grilles with filter grilles for greater client accessibility shall be allowed.

7420 Power Supply Inspection

The electric power supply for all applicable heating units shall be inspected for safety hazards at the time of the initial audit.

7430 Heating and Cooling Line Inspections

All fuel-fired heating units shall be inspected for leaks in the fuel supply at the time of the initial audit and again at the time of final inspection. Fuel leaks shall be corrected before weatherization can continue. All air conditioning units shall be inspected for refrigerant leaks at the time of the initial audit and again at the time of the final inspection.

7440 Clearance from Combustibles

Heating units shall have sufficient clearance from combustible surfaces including walls, ceilings, floors, and framing members, as well as from items including stacks of newspapers, rags, oil, gasoline cans, and other such materials.

7450 Venting System Inspection

Functional combustion venting systems in weatherized dwellings including chimneys, flues, and all related venting components shall be inspected as per applicable standards listed herein to ensure that the systems are both safe and code compliant. For the purposes of the Installation Standards, a functional combustion venting system shall be defined as any system that is actively or could reasonably be placed in service with minimal effort by the dwelling occupants. Examples of nonfunctional exhaust venting systems shall include, but not be limited to, chimneys that have been permanently closed off and no longer penetrate the roof, which have been filled using some other permanent fill method, or which have been walled-in or covered-over in a manner which clearly indicates an intent to place the chimney permanently out of service.

While venting evaluation and installation requirements vary by venting system type and local code, all functional exhaust venting systems present in weatherized dwellings shall generally be evaluated to ensure that:

- A) Vent piping is properly rated for use on the unit type, fuel source, and in the environment to which it is exposed;
- B) Masonry chimneys are appropriately lined;
- C) Venting is free of obstructions, corrosion, residue, and deposits which may hinder proper drafting;
- D) Venting components are well connected and sealed where applicable;
- E) Vent connectors are installed with adequate slope and the fewest elbows possible;
- F) Venting passing through the roof shall have compliant clearances from roofing materials;
- G) Where two units share a common main vent, the unit with the lower Btu input is vented above the higher Btu unit and the size of the common main vent is adequate to properly vent the Btu input of both units;
- H) Venting that is over sized due to removal of one or more combustion appliance (orphaned vents).

7460 Evaluating Air Flow

The airflow of forced air systems shall be evaluated to ensure they are operating within manufacturer's specifications.

7500 Heating, Ventilating, and Cooling System Repairs

Where conditions warrant system replacement, weatherization service providers must use HVAC Subcontractor Agreement Schedule B price lists for these costs, unless weatherization service providers' procurement policies warrant otherwise. In the case of major system repairs, weatherization service providers must have repairs completed by HVAC subcontractors in the most cost-effective manner.

Repairs shall be considered cost-effective where repair expenses do not exceed 1/3 of the replacement cost of a comparable installed unit.

Where repairs can be made for less than \$1000.00, such repairs can be made using program operation funds as an efficiency measure, either by the HVAC technician performing the evaluation or a different HVAC contractor. Weatherization service provider must be notified prior to repairs being made and a supplemental work order generated and kept in the client file.

7600 HVAC System Replacements

Every effort shall be made to repair an existing heating system prior to considering replacement. Replacement shall be considered justified where repair expenses are equal to 25% or greater of the expense of a comparable replacement unit. A load calculation shall be used to determine correct sizing of central forced air replacement units taking estimated post-weatherization dwelling characteristics into consideration. Care shall be taken to ensure that the replacement unit is suitable for the dwelling and that associated system components including the location, power supply, venting, and duct systems are compatible with the replacement system. Code requirements may require replacement of power supply and venting components. The inoperable/unsafe older system shall be surrendered by the owner and permanently removed from the dwelling and properly de-manufactured prior to proceeding with weatherization.

In heating systems with both indoor and outdoor components, both components shall be replaced to ensure proper efficiency and that the indoor and outdoor units are compatible. Mismatched units will result in lower efficiency ratings and can damage the life of the heating and/or cooling system. Exceptions to this regulation must have state approval on a case-by-case-basis.

Installation of 90+ efficiency direct vent furnaces in attics and crawlspaces can result in freezing of condensate lines, resulting in water damage to dwelling. As a result, installation of 90+ furnaces in these locations must be done exactly as manufacturer recommends. If manufacturer does not recommend installation in these areas, furnace must be relocated to a compliant area.

In areas where there is a considerable risk of theft, or previous theft of an outdoor unit has occurred, fencing around the outdoor unit is allowable as an incidental repair and can be charged to HARRP or Health and Safety as applicable.

Inability by the dwelling occupants to supply fuel for an existing primary heat source(s) shall not constitute justification for a system replacement. Documentation justifying the necessity and dwelling owner authorization, as well as the specifications and selection criteria for every system installed, shall be maintained in the job file.

Vented solid-fuel burning stoves can be replaced only if they are the primary heat source. Safety inspections for existing wood stoves must include: 1) wood stove is installed on a non-combustible floor protector heat shield; 2) floor protector heat shield extends 18” from wood stove on all sides; and 3) wood stove has 18” clearance from walls and other combustibles.

Weatherization service provider shall ensure that all HVAC equipment installed using WAP or HARRP funds has been registered, the full warranty is active, and this information has been provided to the client prior to payment for services rendered.

7610 Replacement System Efficiency Requirements

Installed heating systems shall have a performance efficiency of not less than the following:

Fuel Source	Coastal	Non-coastal	Space Heaters
Propane/Gas Furnace	90% AFUE*	90% AFUE*	80% AFUE
Oil Furnace	85% AFUE	85% AFUE	80% AFUE
Propane/Gas Packaged Unit	80%	80%	Not applicable
Propane/Gas/Oil Boiler	90% AFUE*	90% AFUE*	N/A
Heat Pump Split	7.5HSPF2 14.3 SEER2 ▲	7.5 HSPF2 14.3 SEER2	Not applicable
Heat Pump Packaged	6.7 HSPF2 13.4 SEER2	6.7HSPF2 13.4 SEER2	2.6 COP
Mini Split	Not applicable	Not applicable	8.5 HSPF
Wood Stove (logs)	Not applicable	Not applicable	72%
Wood Stove (pellets)	Not applicable	Not applicable	78%

AFUE-Annual Fuel Utilization Efficiency
 HSPF2-Heating Seasonal Performance Factor 2
 COP-Coefficient of Performance

*90% or greater efficiency unit must get its combustion air from outside the shell of the building.

7620 Central Replacement System Sizing

All installed central heating systems shall be adequately sized for the dwelling based on a properly prepared load calculation. Preparation of a Manual J or comparable sizing tool by the licensed HVAC subcontractor awarded the contract for installation of the unit is required. The WA software may also be used as a comparison guide. Please note that MHEA cannot be used to size the cooling load of a manufactured home.

Weatherization service providers shall be responsible for ensuring the accuracy of the load calculations used to size installed systems. Load calculations shall reflect accurate dwelling-specific data including, but not limited to:

- A) Number of dwelling occupants
- B) Total square footage
- C) Wall, ceiling, and floor square footage
- D) Window schedule
- E) Associated local weather station
- F) Wall and window orientation
- G) **Projected post-weatherization insulation value.**

The weatherization service provider shall review the Manual J to ensure the inputs are consistent with dwelling. Where sizing calculations are performed for systems that include cooling, calculations shall be based on ensuring the cooling load for the dwelling is adequate. Where systems provide only heat, sizing shall be based on supplying the heating load for the dwelling only. In no instance shall a central heating system be sized to provide less than 50,000 Btu/hr. input for site-built dwellings and 40,000 Btu/hr. input for manufactured homes.

Notwithstanding the minimums previously expressed, fuel-fired central systems shall not exceed design specifications by greater than 25%. Heat pumps shall not exceed design specifications by greater than ½ ton.

7630 Heating System Fuel Source Switching

Where it is determined that an existing heating system shall be replaced based on the standards listed herein for allowable heating system replacements, every effort shall be made to provide a replacement system that is comparable to the system being removed, including installation of a system with the same associated fuel source.

Weatherization service providers may consider replacement units with different fuel sources and configurations on a limited case-by-case basis only. Authorization from NC WAP shall be required prior to any system replacement where fuel switching occurs.

Where authorization for fuel switching is requested, weatherization service providers shall compile a cost analysis comparing the expenses related to:

- A) Installation of a comparable replacement system with the same associated fuel source (i.e., replacing a nonfunctioning central oil furnace with a new central fuel oil furnace).
- ~ *Versus* ~
- B) Installation of a comparable replacement system with a different proposed fuel source (i.e., replacing a nonfunctioning central fuel oil furnace with a new electric heat pump).

A complete fuel switching cost analysis shall consist of not less than 2 estimates for the installation of each system type, prepared by a licensed HVAC subcontractor. Each of the estimates prepared shall include all expenses associated with the purchase and installation of both proposed replacement systems. Such estimates shall include, but not be limited to:

- A) Base system price plus all additional materials required;
- B) Efficiency of each system compared;
- C) Fuel lines or piping and associated fuel tanks where applicable;
- D) Labor expenses to install each replacement unit and remove the existing unit;
- E) Thermostat replacement;
- F) Required permits;
- G) Ductwork repairs or modifications;
- H) Sole source justification (if applicable).

Fuel switching shall only be authorized on the basis of the cost-effectiveness to the program. Fuel switching shall not be authorized where an existing unit is functioning properly or where cost-effective repairs to an existing system are possible.

7700 Water Heater Repair and Replacement

Allowable water heater repair measures shall include:

- A) Flushing the tank;
- B) Replacing heating elements (electric);
- C) Replacing ignition mechanisms (fuel-fired).

Water heaters shall be replaced on a case-by-case basis where units are nonfunctioning or functioning improperly and cannot be repaired. Replacement of a conventional residential water heater would rarely, if ever, be justifiable based on an SIR greater than 1.0; therefore, most replacements can be justified only as a health and safety measure. Installed water heaters shall be comparable to the existing unit in size, construction, operation, and fuel source. If combustion water heater is selected, a low nitrogen oxide burner will be required. The inoperable/unsafe older water heater shall be surrendered by the owner and permanently removed from the dwelling and properly decommissioned prior to proceeding with weatherization.

Installed water heaters shall have an energy efficiency factor of not less than:

Water Heater Capacity	Gas	Electric
30 Gallons	0.67 EF	0.94 EF
40 Gallons	0.67 EF	0.93 EF
50 Gallons	0.67 EF	0.93 EF
EF-Energy Factor		

7710 Heat Pump Water Heaters

ENERGY STAR qualified heat pump water heaters utilizing super-efficient technology can cut residential water heating costs substantially. As of the effective date of the Installation Standards, all known heat pump water heaters available have a minimum tank capacity of 50 gals, and due to their construction and method of operation such units cannot be installed in small or tightly enclosed areas.

Heat pump water heaters shall be allowable as an energy conservation measure when installed in dwellings where:

- A) Adequate circulation and utility space exists in the dwelling to accommodate the new appliance
- B) The existing water heating fuel source is electricity
- C) Dwelling occupancy supports the capacity of the new appliance
- D) The capacity of the existing and new appliances has a difference of less than 11 gals
- E) A dwelling specific NEAT or MHEA evaluation yields an SIR of 1.0 or greater for the measure.

7800 Window Air Conditioner Guidelines

Where functioning window or room air conditioners are present in weatherized dwellings, it shall be serviced per manufacturer specifications. This includes cleaning filters, coils, and fan blades, in addition to straightening the coil fins as needed. Repairs to nonfunctioning window or room units shall be allowed on a limited case-by-case basis where repair expenses do not exceed 50% of the expense of an installed replacement unit.

While not a cost-effective energy efficiency measure, window air conditioner installation or replacement shall be allowed where necessary to provide at least *one* "cooling room" for at-risk clients as a health and safety measure in dwellings in which no cooling exists. Where installed, units shall be Energy Star rated, shall not exceed 115 volts, and shall not be equipped with remote control devices. A maximum of one unit shall be provided per dwelling.

Window air conditioners shall be air sealed per applicable air sealing standards. Client education shall be provided on operating expenses, maintenance, and energy losses associated with allowing window units to remain installed year-round. Installation of prefabricated air conditioner covers shall be allowed.

7900 Thermostat Installation

7910 Smart Thermostats

When properly programmed and consistently used, smart thermostats, also referred to as programmable or setback thermostats, can be an effective tool to reduce the energy consumption of central HVAC systems. Despite the potential benefits, smart thermostats are more often used improperly, negating any potential benefits, and resulting in frustration for clients.

Smart thermostats shall be installed only where the dwelling occupants are both willing and capable of properly operating the device, and where written authorization from the dwelling owner is obtained. When installed, smart, programmable, or setback thermostats shall comply with the following specifications:

- A) Be equipped with a large digital display
- B) Be hard-wired with a battery backup
- C) Be equipped with the Smart Response/Adaptive Recovery/Smart Recovery feature
- D) For heat pumps, be equipped with a control to lockout strip heat based on an outdoor temperature of above 40°F if one is not installed.

7920 Mercury Bimetal Thermostats

Existing mercury bimetal thermostats located in site-built dwellings shall only be replaced where they are nonfunctioning and cannot be repaired. Servicing a mercury bimetal thermostat should consist of leveling the device as well as testing the anticipator with an ammeter to ensure it is operating within manufacturer specifications as listed on the device. If these adjustments fail to correct the malfunction, then the thermostat

may be replaced with a basic digital or smart thermostat. Documentation of repair efforts made on the existing device prior to replacement shall be maintained in the job file.

7930 Digital Thermostats

Basic or nonprogrammable digital thermostats are not equipped with energy efficiency features and shall therefore only be installed as a replacement for an existing nonfunctioning basic digital thermostat, or for a nonfunctioning bimetal mercury thermostat which cannot be repaired.

Weatherization service providers shall educate clients on the proper operation of the particular type of thermostat in use in the dwelling.

8000 Duct Sealing and Insulating

Sealing and insulating the distribution system or ductwork for forced air heating systems can improve system efficiency and comfort for dwelling occupants.

Ductwork present in all accessible unconditioned areas of weatherized dwellings shall be sealed to a tightness or pressure of 1.0 Pa or below, as measured using the blower door with the house at -50 Pa WRT to the outside.

Duct tightness testing using the blower door and pressure pan, or a duct blower shall be performed to monitor the effectiveness of measures, ensuring complete tightness is achieved.

Duct sealing and insulating measures shall generally be performed by weatherization personnel. The initial energy audit shall be used to identify required duct repairs or replacements, where present. Where duct connections must be repaired or replaced prior to sealing and insulating, applicable local codes shall govern requiring such work be performed only by licensed HVAC technicians.

Client education shall be provided reinforcing the importance of maintaining unrestricted airflow throughout the system.

8100 Duct Sealing Preparation

Prior to performing duct sealing measures, weatherization personnel shall ensure that:

- A) Faulty connections in the duct system have been repaired or replaced per applicable local code
- B) Supply registers located in conditioned space are open, operable, and unrestricted
- C) Supply and return ducts are clear of obstructions and debris
- D) Ducts connecting to unconditioned spaces (for example, an attached garage) have been sealed in a manner which permanently restricts airflow
- E) Oily residues or deposits (where present) have been cleaned using a solvent such as mineral spirits or denatured alcohol
- F) Duct runs are supported with industry standard straps in a manner that prevents sagging in accordance with manufacturer specifications, but at no greater distance than every 4 feet so that there is no greater than 1" of sag per foot of spacing between supports
- G) Compliant procedures for addressing ductwork treated with tape or other materials suspected of containing asbestos have been implemented per applicable standards listed herein for asbestos hazard management

8200 Duct Sealing

A) Material Selection

Duct mastic, with fiberglass mesh tape as needed, or spray polyurethane foam shall be used to seal ductwork at duct boots or duct connections only. Materials not intended for use on ducts shall not be allowed. All materials shall be installed per manufacturer specifications to the extent such specifications do not conflict with the minimum standards listed herein. standards shall be allowed.

Duct mastic shall have the following specifications:

1. be non-toxic and moisture/mold resistant
2. be UL Listed and labeled per UL 181A or 181B standards
3. be compatible for use on the duct material to which it is applied
4. be either fiberglass infused, silicone infused, or fiber reinforced and have a 50% solids content

B) Application

Detached boot connections repaired by HVAC technicians shall be firmly reattached to the subfloor, taking care to prevent materials from inhibiting register grilles from fitting properly into the boot.

All ductwork located outside the conditioned space including plenums and returns, shall be sealed. Emphasis shall be placed on effectively sealing boot-to-subfloor connections and all accessible joints.

Gaps between existing components of less than $\frac{1}{4}$ in. may be sealed using only duct mastic, as long as the components are greater than 10 ft. away from the air handler (within 10 ft. mastic and self-adhesive fiberglass mesh tape shall be used). Gaps of $\frac{1}{4}$ in. up to $\frac{3}{4}$ in. shall be sealed using a temporary tape prior to sealing, followed by duct mastic with self-adhesive fiberglass mesh tape. Gaps of $\frac{3}{4}$ in. or greater shall be treated by applying sheet metal or valley flashing fastened with screws, then sealed with mastic. Gaps sealed with spray foam insulation are subject to these conditions as well.

Where noncompliant cloth duct tape is present on ductwork, ducts may be effectively treated by applying mastic and fiberglass mesh tape atop the existing cloth duct tape in the same manner specified herein, taking care to achieve a durable, tight seal by applying the materials a minimum of 1 in. beyond the edges of the existing cloth tape.

8300 Duct Insulation

Prior to installing insulation, ductwork shall be repaired and sealed per applicable standards listed herein.

Ductwork and plenums located within *conditioned space* shall not be insulated.

Accessible ducts and plenums located in *unconditioned space* shall be insulated to a minimum value of R-8. Duct insulation measures shall comply with the following specifications:

- A) Installed with reinforced foil-wrapped to prevent deterioration due to UV light.
- B) Installed with the vapor barrier on the outside such that it covers the insulation.
- C) Shall not be compressed by greater than 50%.
- D) Shall not be installed where ducts or heating pipes are located within 3 inches of heat-producing devices like flue pipes.
- E) Ductwork insulated to a value of R-4 or greater shall be repaired as needed, but no additional insulation shall be installed.

Care shall be taken to properly identify areas of unintentionally pressure-connected space. The space must be assessed to determine if the space will remain a pressure-connected or if measures will be done to disconnect the space from the rest of the dwelling. Unintentionally pressured-connected spaces are defined as spaces having zonal pressures not greater than 10 Pa WRT the house including, for example, basements, dropped ceilings, and HVAC chases. Ducts located in unintentionally pressure-connected space shall not be insulated. Air handler units, gas packs, and combustion exhaust venting shall never be insulated.

8310 Flex-Duct-to-Boot-Collar Connections

Where flex duct is attached to boot collars, the connection shall be sealed as follows:

- A) Ensure flex duct and boot are well connected and the metal collar is clean.
- B) Apply a band of mastic approximately 2 in. wide around the entire circumference of the existing collar connection.
- C) Pull any loose inner liner up and over the collar and mastic and secure with a code-compliant tie.
- D) Pull outer insulation layer and liner up and over the collar (taking care to fully insulate the boot) and secure with a code-compliant tie.
- E) Apply additional mastic atop the joint to form a complete seal between the duct liner *and* the adjoining surface.

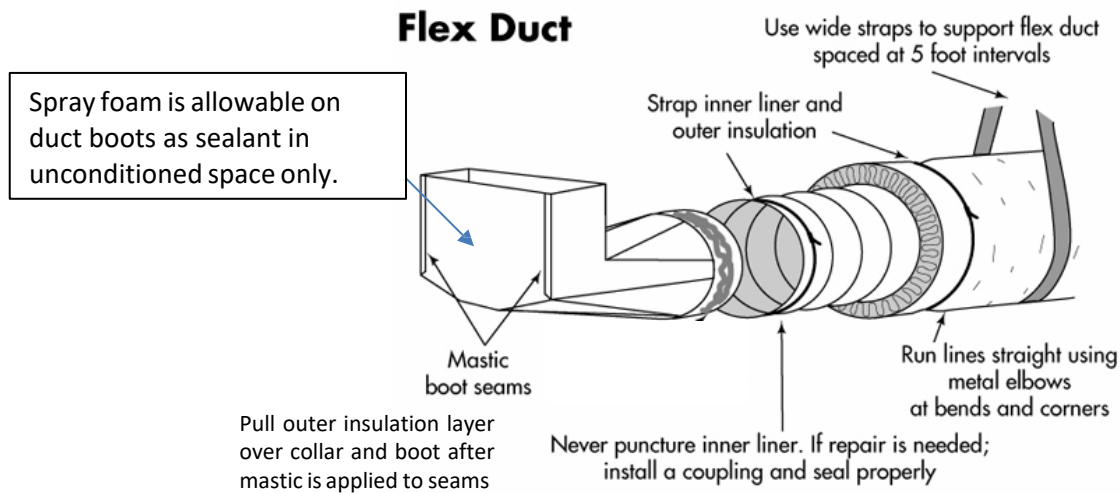

8400 Distribution System Replacement

Every effort shall be made to repair existing distribution system components before replacement is considered. Where complete or major ductwork replacement is required, weatherization service providers shall be responsible for documenting the need for the replacement (including photographs) in the job file. Installation methods and materials used for distribution system replacements shall comply with manufacturer specifications and local code. Duct distribution systems shall not be installed in dwellings that do not have a forced air duct system at the initial audit.

Efforts shall be made to replace panned returns wherever major components of the system are being replaced. Where all or the majority of a distribution system is replaced, all primary supply plenums for distribution of air shall be comprised of rigid duct. Panned floor joists used as supply or return runs shall not be allowed.

Distribution system components shall be sized according to the most current ACCA, Manual D, Residential Duct Systems specifications.

Distribution system replacements shall be completed in a manner which ensures that ductwork:

- A) Is not located in exterior walls
- B) Is not formed using building frame cavities, closets, crawl spaces, or chases for distribution
- C) Does not use panned floor joists
- D) Is not crimped.

Flex duct shall be allowed per applicable code for replacement ductwork installation.

8410 Removal of Vents from Unconditioned Space

Supply and return vents found outside the defined conditions space (such as garages, uninsulated porches, unfinished attics) shall be removed.

9000 Air Sealing Measures

Air infiltration can account for 30% or more of heating and cooling costs in a dwelling and contribute to moisture problems, dust, and the entry of pollutants, insects, and rodents. Reducing infiltration can significantly cut annual heating and cooling costs, improve building durability, and create a healthier indoor environment.

Every dwelling weatherized shall be evaluated to identify air infiltration or leakage sources caused by penetrations in the building envelope, as well as thermal bypasses where heat loss may occur. All air infiltration sources identified which can be corrected cost-effectively through performance of allowable air sealing measures shall be fully addressed.



Repair work required to alleviate poor Indoor Air Quality (IAQ) issues shall be completed prior to performing air sealing measures including, but not limited to, eliminating moisture problems, reducing elevated CO levels, correcting noncompliant combustion appliance venting, etc.

A properly calibrated blower door and infrared camera shall be used to guide the air sealing by helping to diagnose sources of air leakage not easily identified by visual inspection. Air sealing measures shall generally be performed until sealing is no longer cost-effective.

Air sealing measures shall address primary sources of air leakage first, followed by duct leakage, then progress to discrete or secondary leakage sources. Air sealing shall be prioritized beginning with the attic or uppermost areas of the dwelling and ending with the crawl space or lowest area of the dwelling.

Air sealing measures shall be performed regardless of performance of related measures including, but not limited to, attic, sidewall, floor, or duct insulation.

9100 Air Sealing Precautions

Applicable standards specifying appropriate handling and use limitations for hazardous materials shall apply to all materials and installation methods employed during the performance of air sealing measures including, but not limited to, restrictions on the use of spray polyurethane and extruded polystyrene foam products.

Low-Pressure SPF

Low-pressure SPF systems are two-component polyurethane foam products. They are typically delivered to the job site in pressurized canisters (~250 psi), dispensed through unheated hoses through a disposable mixing nozzle system, and applied as a froth-like material to substrate. This type of SPF product is typically used for large sealing and small-scale insulation products. Currently it is not cost effective for the WAP program to install high pressure SPF.

Manufacturer Installation Instructions

In addition to the guidelines above, SPF applicators should follow all manufacturer installation instructions for the product being used. These instructions include product-specific documents such as application instructions, MSDSs, and evaluation reports.

Flexible air barrier materials and rigid board insulation (blue board for example) are allowable materials for use in air sealing in unconditioned spaces provided they have a flame spread index rating of 25 or less and a smoke developed index of 450 or less per NC residential code.

9200 Primary and Secondary Air Sealing

Primary air sealing measures address larger sources of air leakage or infiltration that often may be diagnosed through visual inspection. Secondary air sealing measures address smaller sources of air leakage that may not be easily visible but are often still cost effective to correct. Primary and secondary sources of air leakage include, but shall not be limited to:

- A) Holes in ceilings, walls, floors, or doors
- B) Missing or broken windows
- C) Missing dampers in chimneys, furnace flues, and exhaust fans
- D) Leaks around window air conditioners.
- E) Penetrations around chimneys, flues, and exhaust vents
- F) Penetrations around plumbing and heating pipes
- G) Penetrations around electrical service entries and wiring
- H) Gaps between interior wall top plates
- I) Repairing or repositioning door lock sets, strike plates, and stops
- J) Repairing or replacing window sash latches
- K) Loose window glazing (where panes are in jeopardy of falling out only).

Discrete air sealing measures shall be performed after primary and secondary air sealing and duct sealing measures are complete using the blower door guided cost effectiveness chart.

9210 Air Sealing Basements, Crawlspace, & Garages

9250 Window and Door Assessment

Windows and doors were once thought to be a major air leakage problem. However, since the widespread use of blower doors and the realization that most homes have gaps in the air barrier, window and door air sealing and replacement have been de-emphasized.

Windows and doors remain very important building elements and their repair or replacement can contribute to energy savings. Window and door measures shall comply with applicable standards listed herein governing lead-safe work practices and SHPO project review guidelines as well as with applicable local codes.

Storm windows shall only be installed on site-built dwellings when cost justified with a properly run NEAT audit.

9251 Window and Door Egress

The following egress minimums shall apply to window and door adjustments and repairs:

- A) All functioning egress windows (as defined by local code) shall remain functional.
- B) Non-egress windows may be permanently closed with written authorization from the dwelling owner.
- C) Where there are two or more existing egress doors on the ground floor, at least two doors shall remain functional.
- D) Additional exterior doors may be permanently closed where conditions warrant, with written authorization from the dwelling owner.
- E) At least one egress door on a second or higher floor (where applicable) shall remain functional.

9260 Window Repair

Window repair measures shall comply with the following:

- A) Wherever practical, windows shall be repaired rather than replaced.
- B) Missing, broken, or severely damaged panes of glass shall be replaced as needed as an air sealing measure and to maintain building durability. Untreated wood shall be primed to ensure durability.
- C) Window glazing, with an appropriate glazing compound and glazing points, shall only be replaced where the existing glazing is deteriorated to the point the panes are in jeopardy of falling out of the sash. Re-glazing wood windows may not be a durable repair without scraping, priming, and painting.
- D) Window stops shall be adjusted if large gaps exist between stop and jamb.
- E) Damaged decorative window glass shall be replaced with standard glass pane. If the client refuses a standard window glass pane, their window glass shall be repaired with clear silicone caulk or a material specifically designed to repair glass.
- F) Ensure that window operates smoothly following stop adjustment.
- G) Window repairs shall not extend beyond those measures required to enable the window or door to close properly.
- H) Improperly functioning, non-egress, jalousie windows located in site-built dwellings may be permanently closed from the exterior using screws and a clear exterior grade adhesive, with written authorization from the dwelling owner.

9261 Window Replacement

Window replacement measures shall be an allowable energy efficiency measures when the replacement can be supported (or cost-justified) by obtaining a measure SIR of 1.0 or greater in the WAweb.

Under no circumstances shall requests by the client, comfort concerns, aesthetic issues, or statements made by medical professionals, serve as justification for window or door replacements. Window and door replacement measures which are improperly documented, or that are not cost-justified may be disallowed.

- A) New primary windows shall have a National Fenestration Rating Council (NFRC) U-factor of 0.33 or lower, a Solar Heat Gain Coefficient of .22 or lower.
- B) Damaged framing shall be repaired prior to installing the new window.
- C) The cavities around the window frame shall be insulated with closed cell polyethylene foam or sealed with non-expanding foam sealant. If in good condition, the existing casing may be reinstalled.
- D) New casing shall match the existing in design and dimension as closely as possible.
- E) Interior and/or exterior walls damaged when replacing the window shall be repaired with like materials.
- F) New sash sections shall match the existing in design, as closely as possible.
- G) Jamb liners may be installed.

9270 Door Repair

Door repair measures shall comply with the following:

- A) Wherever practical, doors shall be repaired rather than replaced.
- B) Door repairs shall not extend beyond those measures required to enable the window or door to close properly.
- C) Permanently closed doors shall not be made functional.

9271 Door Replacement

Door replacement measures shall be an allowable energy efficiency measures when the replacement can be supported (or cost-justified) by obtaining a measure SIR of 1.0 or greater in the WAweb.

Under no circumstances shall requests by the client, comfort concerns, aesthetic issues, or statements made by medical professionals, serve as justification for window or door replacements. Window and door replacement measures which are improperly documented, or that are not cost-justified may be disallowed. Replacement Door Installation Standards shall comply with the following:

- A) Replacement doors shall be solid core, wood-insulated or pre-hung metal insulated doors. Doors shall be Energy Star® rated whenever possible.
- B) Existing locksets may be reinstalled on the new door.
- C) The existing casing may be reinstalled but if new casing is needed, the casing shall match the existing in design and dimension, as closely as possible. The cavities around the door frame shall be insulated with closed cell polyethylene foam or sealed with non-expanding foam sealant.
- D) All door casings shall be caulked.
- E) Doors shall conform to the thickness of the existing jamb.
- F) Solid core doors shall have 3 hinges.

9400 Thermal Bypasses

A thermal bypass refers to areas within a dwelling where unconditioned air can interact with a non-insulated air barrier. Effective identification and treatment of thermal bypasses is critical to achieving energy efficiency and occupant comfort. While measures to address thermal bypasses are performed with the same materials and techniques as air sealing, addressing thermal bypasses may have no impact on air sealing diagnostics. Common examples of thermal bypasses include, but shall not be limited to:

- A) Interior wall cavities
- B) Mechanical chases
- C) Dropped ceilings
- D) Sloped ceilings
- E) Junctures between floor levels
- F) Rim joists
- G) Knee walls
- H) Stairwells adjacent to unconditioned space
- I) Cantilever framing details (overhangs, bay windows, etc.).

9500 Air Sealing Window Air Conditioners

Where possible, dwelling occupants shall be encouraged to remove and store window air conditioners when not

actively in use. Window air conditioners that remain installed year-round shall be treated by air sealing the unit using a combination of extruded polystyrene foam board, solid thermal barrier (such as plywood), and one-part interior grade non-expanding spray foam or by constructing a wood frame extension around the unit so an interior storm can be fitted over the unit when not in use.

Providing air conditioner covers shall also be allowed.

9600 Air Sealing Near Heat Sources

Special precautions shall be required when air sealing penetrations around chimneys, furnace flues, and heat pipes due to potential fire hazards. In addition to stopping the flow of air around the heat source, insulation blocking shall also be installed per applicable blocking standards for insulation installation to restrict insulation from coming in contact with the heat source. Air sealing measures needed where potential fire hazards exist shall comply with the following minimum standards:

- A) A fire rated medium shall be installed to seal gaps or chases greater than $\frac{1}{4}$ in. in width around chimneys, flues, or heat pipes.
- B) Gaps of $\frac{1}{4}$ in. in thickness or less shall be sealed with a caulking agent that meets the Underwriters Laboratory (UL) *T-rating* for fire resistance for the fire rated medium being used.
- C) The fire stopping medium shall consist of aluminum or galvanized steel sheets not less than 26 GA in thickness or a similar noncombustible sheet material not more than $\frac{1}{2}$ in. in thickness.
- D) Combustible sheet goods, including extruded polystyrene foam board and products made of wood, shall not be used for this purpose.
- E) The fire stopping medium shall be sealed to the heat source and the surrounding framing and finish materials with a caulking agent that meets the Underwriters Laboratory (UL) *T-rating* for fire resistance for the medium being used.

10000 Insulation Measures

In order to maintain the greatest energy efficiency possible, a dwelling's air barrier or pressure boundary must remain in continuous contact with the dwelling's thermal barrier or insulation boundary. Therefore, to maximize the benefit of weatherization measures performed insulation shall be installed without voids or gaps, shall not be compressed (thus reducing the effectiveness of the insulation), and shall be protected from moisture and air intrusion. Insulation measures shall be prioritized by first treating the dwelling attic, sidewalls, and then floors.



Where adequate insulation exists in a dwelling pre-weatherization and insulation measures are therefore not specified, related air sealing measures shall still be mandated.

10100 Attic Insulation

Attics in weatherized homes shall have an R-value of not less than R-38 post- weatherization, unless structural limitations such as, but not limited to, dwellings with low pitched roofs or floored attics.

Insulation shall be installed in a manner that eliminates voids and areas of inadequate coverage. R-value requirements withstanding, attic insulation depths shall also be adequate to ensure a uniform, settled coverage depth of not less than 2 in. above the measured height of rafter beams in contact with the ceiling.

Justification shall be required for any instance where the standard minimum attic R-value cannot be installed and such justification (including photographs), shall be maintained in the job file.

10110 Pre-Insulation Attic Inspection

Prior to installing insulation, a thorough inspection of the attic area shall be performed. Inspections shall include a determination of the R-value and integrity of existing insulation, the location of air penetrations or bypasses between the conditioned space and the unconditioned attic, and the suitability of the ceiling structure for receiving insulation. Inspections shall further identify any necessary attic repair work, with an emphasis on work related to roof leaks or other moisture-related issues. Necessary repairs shall be completed prior to proceeding with work.

All mechanical exhaust venting shall be confirmed to terminate outside the roofline or sidewall. No exhaust vents shall terminate in the attic.

Electrical wiring in attic areas shall be inspected to confirm that wiring is not cracked, blistered, or deteriorated and that circuits show no evidence of overloading. Attics containing knob and tube wiring shall be treated in

10120 Pre-Insulation Attic Preparations

In addition to the standards for performance listed herein, weatherization service providers shall additionally ensure that all materials used to perform attic insulation measures (in particular, extruded polystyrene foam i.e., blue board) comply with applicable local codes.

- A) Duct Sealing — Ductwork located in attics shall be sealed and insulated per applicable standards for duct sealing and insulating prior to installing attic insulation.
- B) Blocking — Blocking shall be installed prior to attic insulation measures to restrict insulation as needed.

Blocking shall be:

1. formed using a rigid sheet good (such as Thermo-ply)
2. strong enough to withstand the weight of the insulation installed
3. installed at a height of 1 in. or greater above the installed depth of the insulation
4. installed in a manner that provides for a continuous insulation depth to be uniformly achieved above conditioned space.

Blocking shall be provided where a barrier is required to restrict insulation:

1. from coming in contact with heat sources such as functional masonry chimneys, furnace flues, or heating pipes
2. from entering the operating mechanisms of devices such as whole house fans
3. to only those areas located above conditioned space (for example, to partition an attic located above both a conditioned main dwelling and an unconditioned garage)
4. to provide code compliant access to mechanical equipment located in the attic where required
5. From clogging a combustion air opening that connects combustion appliance zone to attic.

Blocking for Attic Storage – Blocking shall be installed in floored attics to restrict insulation, allowing for a limited area of attic storage post-weatherization. Where attic storage is installed by the Weatherization Service Provider, such storage areas shall not be larger than 32 ft² in total area and shall be accessible directly from the attic access. Insulation shall be installed beneath any such floored storage area per applicable standards listed herein.

Blocking for Heating Exhaust Venting – Blocking installed specifically to restrict insulation from coming in contact with potential heat sources including functional masonry chimneys, furnace flues, and heating pipes shall be formed from a galvanized steel or aluminum sheet good not less than 26 GA in thickness or a similar noncombustible sheet good shall be required. Aluminum flashing shall not be used for this purpose. Blocking shall be affixed to the dwelling structure to ensure a minimum 3 in. clearance is maintained on all sides between blocking and heat sources and, where applicable, shall be notched to avoid contact with electrical wiring.

Blocking for Non-Heat Producing Mechanical Devices – Functional non-heat producing mechanical devices located in attics, including whole house attic fans, shall be blocked, and covered providing a sturdy non-permanent, but still airtight, housing around the device to restrict insulation from coming in contact with the operating mechanisms. The cover shall be removable such that the device may be uncovered and operated seasonally without disturbing the adjacent insulation.

Heat Producing Mechanical Devices – Insulation may be installed directly over heat producing mechanical devices that are airtight and rated IC (Insulation Contact) only. No insulation, including fire rated insulation, shall be installed over non-airtight and/or non-IC rated devices.

Where non-IC rated recessed lighting fixtures must be addressed in order to provide uniform insulation coverage, replacement of the existing non-IC rated fixtures with comparable, airtight, IC rated fixtures is the preferred method. LED IC rated lighting kits, or UL approved attic light covers that can be air sealed are also allowable. Light covers that require venting, or are over 16" in height, shall not be allowed.

Wind Baffles — Free circulation of air through soffit vents shall be maintained at all times through the use of rafter chutes or wind baffles designed specifically to restrict insulation moving. Where installed, baffles shall be continuous from the soffit vent to roof decking, shall be the appropriate width to align with the roof framing, and shall be secured to avoid movement. Rafter vents that do not fasten to the top plate shall not be allowed.

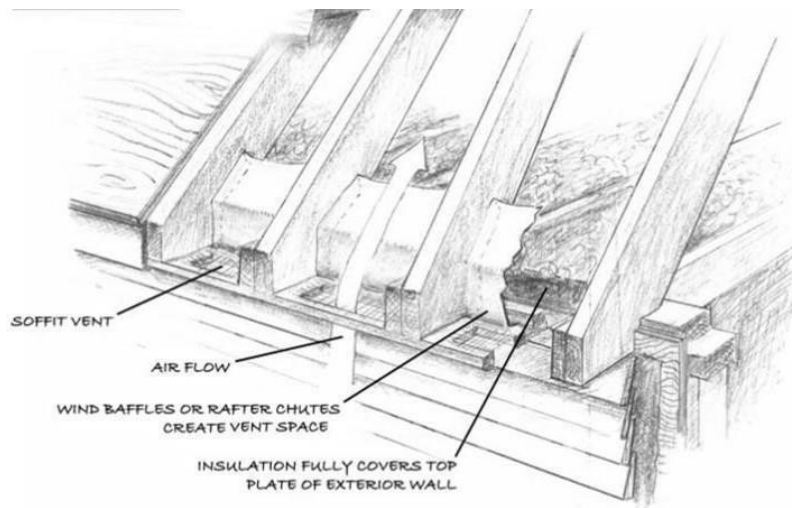

Wind Baffle/Rafter Chute Diagram

Depth Markers — Depth markers shall be affixed to framing members throughout the attic space in a manner that ensures that a clear and accurate representation of the uniformly installed insulation depth is provided. Depth markers shall be located every 6-10 ft. and shall face the attic access where possible.

Junction Flags—Junction flags shall be installed to identify the location of all electrical junction boxes and lighting fixtures prior to insulation installation.

10130 General Attic Insulation Guidelines

Bag Counts—Calculations based on a count of the number of bags used, as per manufacturer specifications, shall be the preferred method for determining the proper quantity and density of material that shall be installed to achieve a specified R-value.

Material Selection — Insulation products selected shall be appropriate for the conditions present in the dwelling and shall be installed per manufacturer specifications. Where a dwelling structure may not support the weight of a heavier insulation material such as blown cellulose insulation, a lighter weight blown insulation material shall be installed. Where existing insulation may be compressed beneath the weight of heavier blown cellulose insulation

resulting in a reduction in the effective R-value of the batts, a lighter weight blown insulation material shall be installed.

Floored Attic Installation — Where insulation is installed in a floored attic using the drill-and-blow method, holes shall be properly plugged, secured with adhesive, and sealed. Floor planks may also be removed to allow for access to blow cavities, and then reinstalled.

Insulation Certificates—Insulation certificates containing the following information shall be installed at or near the attic access in every dwelling weatherized:

- A) insulation type
- B) Coverage area
- C) stated R-value
- D) bag count installed (#)
- E) anticipated settled depth
- F) installation date
- G) business name of the install firm
- H) SDS information.

10140 Attic Accesses

Access to the attic shall be provided in all dwellings weatherized for purposes of post-weatherization inspections and potential future needs of the dwelling occupants. Existing attic accesses shall comply with applicable standards or installation of a new access shall be required.

Compliant interior attic accesses shall:

- A) Have existing dimensions of not less than 16 in. by 24 in., or where new attic hatches are installed by weatherization crews, have dimensions of not less than 16 in. by 30 in.
- B) Be located in area of the dwelling that allows for entry and exit from the access without disturbing major appliances or furnishings (for example, hallways or unobstructed utility rooms)
- C) Have an air sealed weather-stripped (self-adhesive permissible) cover, insulated to not less than a value the surrounding insulation, which may be easily opened by dwelling occupants
- D) Be strong enough to support the weight of an average sized adult entering or exiting the attic
- E) Where required, insulation blocking around attic accesses shall be installed per applicable blocking standards
- F) Must include a finish material (for example, 2-3 in. primed trim molding made from medium density fiberboard) which provides a workmanship-like appearance.

Prefabricated attic access kits or treatments which meet the minimum standards listed herein (including Energy Guardian kits) shall be allowed. Zippered attic hatch tents shall be allowed. Attic accesses located in unconditioned space shall not be insulated or weather-stripped. Adding a latch, lock, or frictional device to ensure a good air seal is a requirement for attic hatches.

10150 Vaulted or Sloped Ceiling/Roof Cavities

Vaulted ceilings, sloped ceilings, or roof cavities shall be insulated to a value of no less than R-19, whenever

possible. Where it is not possible to insulate to R-19, the limiting factor(s) shall be documented in the job file. A backing consisting of a rigid sheet good such as lauan, Thermo-ply, or Thermax shall be installed to hold insulation in the roof cavity. Extruded polystyrene foam shall not be used. Where fiberglass batt insulation is installed, the attached vapor retarder shall always face conditioned space. Where blown fiberglass insulation is installed, the material shall be filled to capacity in the vaulted or sloped ceiling or roof cavities with **no** soffits. An air space must be maintained in cavities with soffits.

10160 Knee Wall Accesses and Insulation

Access to knee wall areas shall be provided in all dwellings weatherized for purposes of post-weatherization inspections and potential future needs of the dwelling occupants. Existing knee wall accesses shall comply with the standards below or installation of an additional access shall be required. Interior knee wall accesses shall be:

- A) No less than the width of the knee wall stud cavity by 24 in. in height;
- B) Air sealed, weather-stripped, and insulated to no less than R-15;
- C) Open joists under knee walls shall be air sealed with blocking behind the bottom plate, and not flush;
- D) Secured with no less than one latch to ensure air tightness.

Adjacent knee wall cavities shall be air sealed and insulated to no less than R-15 using fiberglass batt or blown cellulose insulation installed at a density of 3.5- 4.5 lb./ft³. A backing consisting of a code compliant rigid sheet good or code compliant flexible air barrier shall be installed to hold insulation in the wall cavity, provided they have a flame spread index rating of 25 or less and a smoke developed index of 450 or less per NC residential code.

Where it is not feasible to provide permanent access to knee wall areas, the attic and/or knee wall area shall be inspected by an auditor/final inspector prior to access to the area being sealed. Measures installed in the knee wall area shall, for documentation purposes, be photographed prior to the access being sealed and justification of the need to seal the access, as well as photographic documentation of the measure performed on the interior of the knee wall space, shall be maintained in the job file. Prefabricated knee wall access kits or treatments which meet the minimum standards above shall be allowed.

10200 Sidewall Insulation

Dense-packed sidewall insulation shall be installed where non-insulated wall sections exist, including walls that separate conditioned space from unconditioned space such as garages or unheated porches. Where incomplete sidewall insulation exists, insulation shall be added to provide complete sidewall coverage.

Applicable standards for local code compliance shall apply to the installation of sidewall insulation. Applicable standards for lead-safe work practices shall additionally apply to sidewall work on dwellings built in 1978 or before. Applicable standards for SHPO approval shall apply to dwellings 45 years or older where sidewall insulation is required.

Exceptions to the requirement of installing sidewall insulation may include:

- A) No wall cavity
- B) Interior and/or exterior walls too weak to withstand pressure of sidewall insulation
- C) Existing wall insulation
- D) Inset Chimneys must be addressed on a case-by -case basis with state approval.

Justification for any omission of sidewall insulation shall be well documented. Exceptions shall be allowed only where reasonable justification exists and the course of action selected is clearly evidenced. The presence of brick as an exterior cladding **shall not** constitute reasonable justification not to install sidewall insulation.

Weatherization service providers shall be responsible for ensuring adequate justification and documentation for such exceptions is maintained in the job file.

10210 Pre-Insulation Sidewall Inspection

Both the interior and exterior of all dwellings shall be inspected prior to installation of sidewall insulation. Repairs required as a result of the inspection shall be performed prior to insulation work commencing. All deficiency conditions observed and the manner in which each was resolved shall be documented in the job file.

Interior Inspection — At minimum, interior wall inspections shall identify and document:

- A) presence of existing sidewall insulation, as evidenced by manually testing at least three stud bays on 3 different walls.
- B) any areas of the interior wall surface which are weak or not securely fastened
- C) location of all exterior wall-mounted switches and outlets, chases, utility runs, duct runs, wall heaters, vent fan penetrations, etc.
- D) any interior soffit areas, pocket doors, or other structural details that may need preparation prior to insulating
- E) critical framing junctures which impact the ability of the wall to contain high-density insulation.

Exterior Inspection — At minimum, exterior wall inspections shall identify and document:

- A) type(s) of siding material present, especially siding material that may contain asbestos and/or lead-based paint.
- B) best drilling strategy, including whether siding may be lifted or temporarily removed to drill subsiding or sheathing
- C) severely deteriorated window or door components or damaged, rotted, or deteriorated siding which requires replacement to ensure the integrity of the insulation
- D) the source of any moisture in wall cavities
- E) structural additions and critical junctures which impact the ability of the wall to contain high-density insulation
- F) any obstructions near the perimeter of the dwelling which must be removed to provide access to the wall cavity during installation.

10220 Pre-Insulation Sidewall Preparation

- A) Air Sealing — Walls shall be air sealed prior to installation of sidewall insulation, including the sealing of top
- B) and bottom wall plates, particularly in dwellings with balloon framing.
- C) Blocking — Construction details that allow insulation to escape from sidewall cavities (such as balloon framed walls) shall be blocked in a manner that effectively retains the insulation.
- D) Plugging, Patching, and Finishing

Exterior:

1. Where exterior lap siding is removed, and holes drilled in the sheathing and/or subsiding for the installation of insulation, holes in the exterior subsiding may be patched using wood plugs, plastic plugs, or shall be sealed using construction adhesive.
2. Where holes are drilled through exterior siding, plugs installed, and any wood or siding replaced shall be compatible with the exposed surface that has been drilled and shall be sealed and primed.

Interior:

1. Where possible, holes drilled during interior applications shall be drilled in a manner such that they may be covered using primed medium-density molding of not less than 4 in. in width. Plugs shall not be required in such applications.
2. Where holes must be drilled in interior wall surfaces where covering them with molding is impractical, plugs installed shall consist of a material which is compatible to the existing interior wall surface. Compatible plugs shall be sealed and primed so as to be "paint ready" post-installation.

10230 General Sidewall Insulation Guidelines

Sidewall insulation shall be installed according to the manufacturer recommendations for density and in a manner that does not allow the material to settle. Cellulose is the preferred material for dense-pack sidewall insulation. When insulating sidewalls with blown cellulose, it shall be installed at a density Between 3.5 – 4.5 lbs./ft³ using the tubing method. Blown shall not be installed against chimneys or certain electrical fixtures. Where blown fiberglass is required, it shall be installed at a density of 1.6 lb./ft³.

The quality and quantity of sidewall insulation installed shall be assessed post-installation using an infrared camera and by using the calculation method based on dwelling square footage and cavity depth. Additional inspection techniques may be used in conjunction with prior methods, including inspection of core samples or using a z shaped test wire.

10300 Floor Insulation

Where floor insulation measures are performed, installed insulation materials shall have a rated R-value of not less than R-19. In dwellings in which structural limitations exist that do not allow for the installation of R-19, the insulation shall be installed to a value of not less than R-11. Where existing floor insulation is present, insulation shall be installed only to correct damaged areas. Existing properly installed insulation that is rated as R-11 shall not be removed to install R-19. Dwellings in coastal areas that have a heat pump as their primary heat source shall not have floor insulation installed without a site specific, computerized audit being performed. The coastal counties are as follows: Beaufort, Bertie, Brunswick, Chowan, Camden, Carteret, Craven Currituck, Dare, Gates, Hyde, New Hanover, Onslow, Pamlico, Pender, Pasquotank, Perquimans, Tyrrell, and Washington.

Exceptions limiting the performance of floor insulation measures shall include:

Crawlspace clearances adequate to allow for installation of insulation in over 60% of the total area shall be considered sufficient to proceed with the measure. In situation where this is not possible, floor insulation shall not be installed. Weatherization service providers shall be responsible for ensuring that adequate justification and documentation for any exception is maintained in the job file.

10310 Pre-Insulation Floor Inspection

All dwellings' crawl spaces and floors shall be inspected prior to installation of floor insulation. All repairs required as a result of the inspection shall be performed prior to insulation work commencing.

At minimum, crawl space and floor inspections shall identify and document:

- A) Presence, condition, and R-value of existing floor insulation
- B) Presence and source of any existing or potential moisture problems
- C) Decayed, broken, or damaged structural components, critical framing junctures, and/or any areas of the floor which are weak
- D) Location of all heat sources, chases and floor penetrations, utility runs, ductwork, etc.
- E) Presence of large obstructions, and/or personal property that must be removed in order for the floors to be insulated effectively.

10320 Pre-Insulation Floor Preparations

- A) Floors shall be air sealed prior to installing insulation as per applicable standards for air sealing listed here. Emphasis shall be placed on air sealing penetrations beneath bathtubs and open bottom plates.
- B) A properly functioning crawl space door including a clasp closure shall be required in all weatherized dwellings.
- C) Where a combustion appliance or flue is present, insulation and other combustible materials shall be kept at a minimum clearance of 6 in. from any such heat source.

10330 General Floor Insulation Guidelines

- A) Insulation with a value of R-19 shall be installed unless prohibited by the depth of the floor joists. In no instance shall insulation have a value of less than R-11.
- B) Insulation shall be installed without voids or gaps and shall fit tightly around cross bracing, framing members, and other obstructions and fastened securely in place with wire fasteners, nylon mesh, or other appropriate fastener. Friction fitting or stapling floor insulation shall not be permitted.
- C) Insulation shall be installed in a manner which ensures continuous contact with the underside of the subfloor and with the rim or band joists.
- D) Fiberglass insulation with an attached vapor retarder shall be installed with the retarder facing upward toward the conditioned space.

11000 Baseload and General Heat Waste

Baseload reduction measures are designed to reduce the energy consumed by inefficient or outdated appliances and can make a substantial difference in household utility consumption. General heat waste measures are measures that are assumed to be cost effective or often serve to increase client comfort.

11100 Refrigerator Evaluation

Refrigerators located in weatherized dwellings shall be evaluated for potential replacement based on energy consumption. **When WAweb NEAT or MHEA audit is required, no separate Savings Investment Ratio (SIR) form is needed.** Refrigerator evaluation criteria shall include the following:

- A) Only one standard, full-size, residential refrigerator or refrigerator and freezer combination (in a two for one trade out) that are actively in use shall be considered for replacement.
- B) The cost-effectiveness of replacing a refrigerator shall be determined by using the annual kW usage of the appliance to calculate the SIR.
- C) For the refrigerator to be replaced, one or more existing refrigeration appliances must be determined to contribute to a combined SIR of 1.0 or greater.
- D) Multiple refrigeration appliances operating in a single dwelling may contribute to a combined SIR of 1.0 or greater; therefore, where present multiple appliances should be evaluated.
- E) Every appliance contributing to a combined SIR of 1.0 or greater resulting in a replacement must be permanently removed from service and appropriately de-manufactured per applicable federal regulations.
- F) Replacement appliances shall comply with applicable federal energy efficiency standards.
- G) A non-functioning refrigerator may be replaced if:
 - A non-DOE funding source is used and;
 - The refrigerator's energy usage can be found in a database and;
 - The replacement refrigerator as an SIR rating of 1.0 or better.
- H) An effective economic life of 15 years shall be used for evaluation purposes.
- I) A minimum of 10% of all appliances replaced shall be evaluated using the metering method, rather than using a database.
- J) Under no circumstances shall a stand-alone freezer be replaced.
- K) Under no circumstances shall a refrigerator be replaced based solely on age or appearance.
- L) Under no circumstances shall a refrigerator be replaced based solely on an operating malfunction not related to energy consumption.

Replacement appliances shall not have through-the-door ice or water features. Exceptions to this rule shall be made only when occupant(s) in the house are wheelchair bound. **Exceptions shall be granted on a case-by-case basis and must have state approval prior to installation.**

Extended warranties are allowed provided the cost of the extended warranty is included in the SIR calculation and that cost does not cause the SIR to fall below 1.0. Agencies are encouraged to purchase the longest warranty period possible provided the final refrigerator SIR is at least 1.0.

11110 (2-for-1) Refrigerator Replacement Option

Households where multiple refrigeration appliances consume energy year-round may benefit greatly from a reduction in the number of appliances in use. Clients should be encouraged to discontinue use of any appliance that is not in active use or that consumes a large amount of energy.

Where a refrigerator-only evaluation results in an SIR of less than 1.0, the annual kW usage of an additional refrigeration appliance may be considered to achieve a combined SIR of 1.0 or greater qualifying the household for a refrigerator replacement.

Example:

Household (A) actively uses one 18 ft³ refrigerator that is 14 years old. Household (A) also actively uses one stand-alone freezer that is 9 years old. Household (A) additionally has a compact or mini refrigerator in the basement that is rarely used but stays on year-round. Under this scenario, the 2-for-1 Replacement Option should be considered for Household (A).

Eligibility for the 2-for-1 Replacement Option would be determined by comparing the cost effectiveness of providing one larger, more efficient refrigerator/freezer combination to replace the existing, inefficient refrigerator/freezer combination and the stand-alone freezer.

Where the combined annual kW usage of the one 18 ft³ refrigerator/freezer combo and the one stand-alone freezer, when compared to the purchase price and annual energy consumption of one new, energy efficient 21 ft³ refrigerator/freezer combination results in an SIR of 1.0 or greater, then the 2-for-1 Replacement Option is appropriate. The inefficient refrigerator/freezer combo and the stand-alone freezer must both be removed and appropriately decommissioned.

Though it may not be considered as part of the 2-for-1 Replacement Option, client education shall additionally be provided encouraging Household (A) to discontinue use of the compact refrigerator located in the basement as a means of further reducing household energy consumption.

11120 Refrigerator Evaluation Methods

Refrigerator evaluation shall occur in two stages:

A) Refrigerators Less Than 10 Years Old:

1. weatherization personnel shall determine the manufacture date of the appliance (when possible) by checking the service tag generally located inside the unit.
2. the model number, serial number, manufacture date, and method of determination shall be documented in the job file.
3. for appliance determined to be less than 10 years, no further action shall be required.

B) Refrigerators 10 Years Old or Older (or where age cannot be determined):

1. annual kW usage shall be determined by either metering or obtaining estimated annual kW usage from an approved appliance database.
2. using annual kW usage data, the cost-effectiveness of replacing the appliance shall be determined by calculating the SIR.
3. refrigerators determined to have an SIR of 1.0 or greater shall be replaced per applicable standards.
4. the SIR, evidence of calculation method, specification data for replacement appliance, and photographic documentation of the appliance removed shall be maintained in the job file.
5. refrigerators with an SIR of less than 1.0 shall not be replaced, except where the 2-for-1 Replacement Option is applicable.
6. Extending the warranty of a refrigerator is encouraged, provided the cost is added to the evaluation and the refrigerator still has an SIR of 1.0 or greater.

11200 Lighting Upgrades

Incandescent bulbs in use one hour or more per day shall be replaced with LED light-emitting diodes (LED). Installed LEDs shall have a lumen rating equivalent to or higher than the incandescent bulb being replaced to maintain equivalent light output levels wherever possible.

No limit shall be placed on the quantity of LEDs installed, so long as usage is evaluated on a case-by-case basis and replacement is supported by the one-hour-or-more daily usage criteria or by a documented SIR of 1.0 or greater. Failing to install LEDs in locations used at least one hour per day shall not be allowed.

Client education shall be provided explaining the differences between LED and incandescent bulbs, including proper disposal methods, and shall be repeated as needed during the installation process.

11300 Water Heat Loss Measures

Water heaters and associated hot and cold-water pipes shall be insulated to reduce conductive heat loss in all dwellings weatherized. Wrapping the cold-water pipes is required because hot water from the tank is pulled up into the cold-water pipes due to thermosiphon action. The first 6 ft. of the hot and cold-water line leading into and out of the unit shall also be insulated.

Water heaters shall be insulated to an insulation value of R10 or greater using mineral fiber insulation with an attached protective backing installed facing outward and banded with zip ties to mechanically fasten the insulation. Foil bubble reflective insulation is not permitted. Exceptions to water heater insulation standards shall include:

- A) Cabinet style water heaters and units labeled with instructions indicating "Do Not Wrap"
- B) Water heaters located within 3 ft. of any type of furnace or stove, regardless of fuel source.

Pressure relief valves shall be present on all units and associated valve piping shall terminate not more than 6 in. above the floor or, depending on local code specifications, terminate outside the perimeter of the dwelling. In localities where outdoor termination is required, valve piping shall have an air gap located in the same room as the water heater, prior to the discharge entering into piping terminating outdoors.

Exceptions to the installation of pressure relief piping to the outdoors standards shall include:

- A) Cabinet style water heaters
- B) Water heater located in underpinned/dugout/excavated basement
- C) Water heater located in the center of a dwelling on the first floor of slab on grade
- D) Water heater located in standalone structure.

Client education shall be provided explaining potential energy savings related to reducing the temperature and quantity of household hot water usage.

Wherever possible, weatherization service providers shall obtain verbal client authorization to adjust water heater thermostat settings to a temperature of 110°- 120°F. Where the client chooses to decline the measure, written documentation shall be maintained in the job file.

A) Electric Water Heater Insulation

The following standards shall apply to electric water heater insulation measures:

1. insulation shall be applied to the top and sides of the water heater.
2. overlapped ends of the protective backing material shall be sealed and banded in order to provide an adequate seal.
3. the pressure relief valve and piping shall not be covered.
4. thermostat controls shall be clearly marked and panels shall be insulated but readily accessible.

B) Fuel-Fired Water Heater Insulation

The following standards shall apply to natural gas and liquid propane water heater insulation measures:

1. insulation shall be applied to only the sides of the water heater.
2. overlapped ends of the protective backing shall be sealed and banded in order to provide an adequate

seal.

3. a clearance of not less than 3 in. shall be maintained between insulation and the base of the appliance.
4. a clearance of not less than 6 in. shall be maintained between tank and/or pipe insulation and the draft hood.
5. insulation shall not cover the pilot light, cut-off valve, the access panel to the thermostat or heating elements, operating instructions, the pressure relief valve or piping, the drain, any electrical service wiring, or the high-limit switch.

11310 Water Flow Reduction Measures

Allowable water flow reduction measures in weatherized dwellings shall include installation of low flow showerheads and faucet aerators. Flow reducers shall be composed of durable materials and shall be as similar in design and finish to the associated fixture as possible.

Water flow reducers that are installed shall be rated to provide a maximum flow rate of:

- A) Shower heads - equal to or less than 2.0 gallons per minute (gpm)
- B) Faucets aerators - equal to or less than 1.5 gpm.

Where the condition of the plumbing is such that damage could result from this installation, this optional measure shall be attempted only by a licensed plumber.

11400 Weather stripping and Door Sweep Installation

These low-cost items target client comfort and shall only be allowed after all other cost-effective energy efficiency measures are complete.

Where weather stripping or door sweeps are installed, only durable materials shall be used. Universal weather stripping kits constructed of vinyl, silicone, or wrapped foam with metal or wood flanges shall be allowed. Self-adhesive or open cell foam weather stripping shall be allowed where use of a more durable product is not feasible for a particular application, but under no circumstances shall it be installed on doors.

12000 Incidental Repairs

Incidental repairs are those repairs necessary for the effective performance or preservation of weatherization materials. Such repairs include, but are not limited to, framing, or repairing windows and doors which could not otherwise be caulked or weather-stripped, installation of a working crawl-space door (required) and providing protective materials, such as paint, used to seal materials installed under WAP. Except where explicitly cited, dwellings that require incidental repairs must have a site-specific computerized audit to ensure that the package of measures do not reduce the overall SIR to less than 1.0. Incidental repairs must be included in the SIR calculation. If the projected incidental repairs drop the total SIR below 1.0 and there are no other non-federal funds to leverage, the dwelling must be deferred, or the measure and incidental repair removed. If the measure and incidental repair is removed, it must be determined if weatherization services can still be rendered. The following incidental repairs must be cost-justified through a properly executed computerized audit:

- A) Repairing minor roof leaks (over 1 sheet plywood or similar material)
- B) Minor floor reinforcement (over 1 sheet plywood or similar material)
- C) Minor ceiling reinforcement (over 1 sheet sheetrock or similar material)
- D) Minor wall reinforcement (over 1 sheet sheetrock or similar material)
- E) Minor moisture diversion or drainage repair

F) Window and door repairs

Incidental repair measures (IRM) with a total cost of less than \$200.00 will not require a site specific computerized audit, as long as the costs are well documented in the client file.

Manufactured Home Section

This section provides guidance and requirements pertaining to manufactured homes. For any processes, procedures or requirements not specifically mentioned in this section, the processes, procedures, and requirements referred to in the current Installation Standards shall also apply to manufactured homes.

22000 Workflow Documentation

22100 Weatherization Assistant Web-Based Energy Audit Software

For manufactured/mobile single family, the Weatherization Assistant web-based (WAweb) suite consists of four audit tools maintained by the Oak Ridge National Laboratory (ORNL) to assist with the implementation of the US Department of Energy's (DOE) Weatherization Assistance Program (WAP). These tools are available for use within WAP and, in certain situations, may be used by utility-based programs and home energy professionals (e.g., in addition to WAP or through previous versions).

WAweb Suite consists of:

- Manufactured Home Energy Audit (MHEA) for manufactured homes.
- Health and Safety Audit for single-family homes (including manufactured homes) and individual dwelling units in multifamily buildings that are being weatherized.

The three energy audit tools identify cost-effective energy-efficiency retrofit measures using site specific weather conditions, construction details, local measure costs, and area fuel costs. The Health and Safety Audit assists in identifying and selecting health and safety measures when a dwelling is evaluated for energy-efficiency retrofits. All tools are available for use through the WAweb platform.

For single family:

NCWAP will be adopting the single-family US DOE "Climate Region 2" priority lists (PLs) for optional use in the NCWAP program for single and multi-family, respectively. This allowance is designed for energy audits to be conducted using predefined lists by housing type when "similar dwelling units without unusual energy-consuming characteristics" exist. The US DOE has determined what these similar dwelling unit types are and what measures should be considered for installation in these dwelling types based on regional differences in climate and energy costs.

These optional regional Priority Lists are not exhaustive and do not include every measure that may be cost effective on a site-specific basis. If a dwelling unit needs measure(s) that are not included within the PL, or if the unit does not meet the basic requirements of the PL, then a site-specific energy audit will be required to be run utilizing DOE approved software (i.e., Weatherization Assistant for the Web (WAweb) for single family) and according to the dwelling type audit protocol. It is important to note that only one tool can be used at each dwelling unit (i.e., not combining factors/elements between the PL and computerized audit tool). Eligibility must be determined prior to utilizing the PLs and have requirements for Health and Safety measures installed according to the Health and Safety Plan.

Subgrantees may not utilize the PL for USDOE units until the NCWAP Program Manager provides official notification to the network via memorandum.

Use of the above tools shall be required for 100% of DOE weatherized dwellings, and 5% of LIHEAP weatherized dwellings. Network will be notified at a time to be determined when 100% of LIHEAP weatherized dwellings will require a computerized audit. Where measures to be performed on a dwelling deviate from the LIHEAP priority list, a computerized audit must be performed to ensure an SIR on each measure, and overall, of at least 1.0.

The Mobile Home Energy Audit (MHEA) portion of the WAweb shall be used for manufactured dwellings. Measures requiring the use of the WAweb software for LIHEAP mobile homes shall include, but not be limited to:

- A) Incidental repairs lacking a direct relationship to priority list measures or exceed \$200.00 per repair.
- B) Comparing heating, ventilating, and cooling (HVAC) system sizing for replacements to Manual J calculations.
- C) HVAC sizing for system installations required to establish adequate primary heat sources.
- D) Mobile homes with any additions.
- E) Window and/or door replacements.

Dwellings in which no air sealing is needed and in which adequate insulation in the attic, sidewalls, and floor is already present shall require a WA audit in order to ensure that the entire job will still be cost-effective. The WA software tools may additionally be used to cost-justify refrigerator replacements and to assess the cost-effectiveness of certain health and safety measures, where applicable, to support leveraging and efficient management or program resources.

Computerized audits must be performed before heating systems are evaluated for replacement (ECT). For the heating and cooling portions of the software, the existing system's data shall be entered.

One or more weatherization personnel members employed by each weatherization service provider shall be certified by an approved training facility in the use of the WAweb (NEAT/MHEA).

22200 State Historic Preservation Office Authorization

Manufactured homes are exempt from SHPO requirements. Even in a historic district, they are considered noncontributing structures.

23000 “LIHEAP” Priority List of Measures Mobile Homes

Measures shall be completed on manufactured homes in the order prioritized below for LIHEAP homes. If a specific measure is skipped without proper documentation or justification, any measures lower on the priority list that are performed may result in disallowed cost.

23100 LIHEAP Priority List of Measures for Mobile Homes

- 1. Energy Related Health and Safety**
(Chapters 5000, 6500, 7000, 24000)

- 2. Duct Sealing**
(Chapter 27000 – Duct Sealing and Insulating)

- 3. Air Sealing**
(Chapters 9000 & 28000 – Air Sealing)

- 4. Lighting**
(Chapter 11000 – Baseload Reduction and General Heat Waste)

- 5. Side Wall Insulation**
(Chapter 29000 – Insulation)

- 6. Refrigerator Replacement**
(Chapters 11000 & 30000 – Baseload Reduction and General Heat Waste)

- 7. Roof Insulation**
(Chapter 29000 – Insulation)

- 8. Floor Insulation**
(Chapter 29000 – Insulation)

- 9. Glass Storm Windows**
(Chapter 28000 and 31000 – Air Sealing)

24000 Health and Safety Provisions

24110 Vapor Barriers

Vapor barriers in manufactured home applications shall only be required in manufactured homes with permanent foundations. Vapor barriers installed under manufactured homes with a permanent foundation shall follow all requirements of their application in single family dwellings.

Vapor barriers are allowable under manufactured homes with and without perimeter skirting but shall not be required. Vapor barriers in manufactured home applications shall not be sealed to perimeter skirting. It is recommended that extra landscaping pins be used to secure the perimeter of the vapor barrier when it is installed for manufactured homes without permanent foundations.

24120 Moisture Diversion

Installation of gutters in the form of J-channel shall be allowed if existing J-channel is damaged in the process of insulating the manufactured home roof cavity. Minor leaks in the J-channel and between the J-channel and the manufactured home shall be sealed with butyl putty tape.

24130 Ventilation

At least one full bathroom in every manufactured home shall be equipped with either a timer-equipped local exhaust ventilation fan, or a variable speed fan capable of continuous use, with a noise rating equal to or less than 1 sone and an installed airflow rate of not less than 50 CFM. To increase the probability of uniform compliance with this standard, devices installed in bathrooms shall have a rated airflow specified by the device manufacturer of not less than 70 CFM.

Exhaust fans that exist at the time of the energy assessment shall be tested (commissioned) by the auditor. If deficiencies are noted, those deficiencies shall be corrected, to the extent practical, during weatherization.

24140 Lead-Safe/Renovate Right

Lead paint was not used in the building of manufactured homes but may be found in varnishes and stains in mobile homes remodeled before 1978.

25000 Diagnostic Testing

25100 Zonal Pressure Diagnostics

Due to differences in construction techniques, zonal pressures of less than 45 Pascals shall be acceptable. ZPDs shall be performed in belly of a manufactured home but are not required in the roof cavity.

In doublewide manufactured homes, ZPDs WRT the conditioned space shall be taken in the marriage wall of the manufactured home. The marriage wall shall be as close to 0 WRT the conditioned space as possible. ZPDs WRT the conditioned space shall also be taken on both sides of the belly in a doublewide manufactured home.

26000 Heating, Cooling, and Ventilating Systems

26100 Fuel-Fired Heat Source Requirements

Manufactured homes shall adhere to the requirements listed in the HUD Mobile Home and Safety Standards (3280.709, G), including, but not limited to:

- A) All fuel-fired appliances, excepting ranges, clothes dryers, and solid-fuel burning fireplace stoves, shall be installed to provide for the complete separation of the combustion system from the interior atmosphere of the manufactured home. This shall be accomplished by installing a sealed combustion direct-vent system.
- B) All fuel-fired appliances, excepting ranges and clothes dryers, shall be equipped with code compliant venting systems capable of close clearances with combustibles materials.
- C) Solid-fuel burning fireplaces or fireplace stoves shall be equipped with integral door(s) or shutter(s) designed to close the fire chamber opening and shall include complete means for venting through the roof, combustion air inlet, hearth extension, a spark arrestor installed on the chimney cap, and means to securely attach the fireplace or fireplace stove to the manufactured home structure.

26220 Replacement System Sizing

All installed systems shall be specifically designed for manufactured homes. At the time of this publication, MHEA is not designed to calculate the sizing of a cooling load for a manufactured home. The chart and diagram below can be used to compare a third-party Manual J or comparable equipment-sizing software results.

Sizing Chart for Cooling Area for Manufactured Homes										
Zone	Floor Area (square feet)									
	1 - 840	841 - 1,120	1,121 - 1,280	1,281 - 1,440	1,441 - 1,680	1,681 - 1,960	1,961 - 2,240	2,241 - 2,520	2,521 - 2,760	2,761 - 3,000
15	1.5	1.5	2	2	2.5	2.5	3	3	3.5	3.5
23	1.5	2	2	2.5	3	3	3.5	4	4	4.5
25	1.5	2	2.5	2.5	2.5	3	3.5	4	4	4.5
26	1.5	2	2.5	2.5	3	3	3.5	4	4.5	4.5
29	2	2	2.5	2.5	3	3.5	4	4	4.5	5
32	2	2.5	2.5	2.5	3	3.5	4	4.5	4.5	5
35	2	2.5	2.5	3	3	3.5	4	4.5	5	5

Adapted chart from the Manufactured Housing Research Alliance

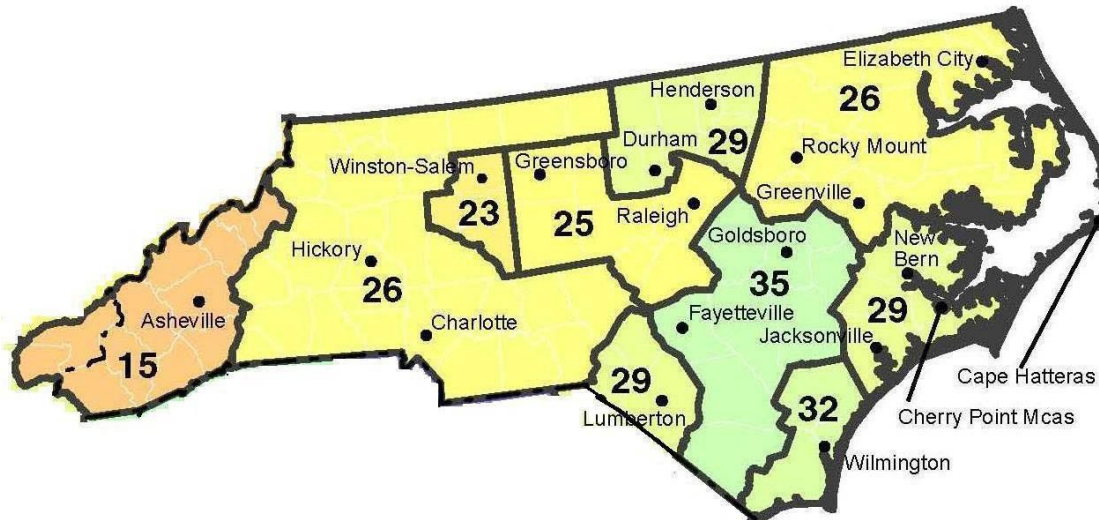

27000 Duct Sealing and Insulation

27100 Duct Sealing

The end of the duct plenums shall be sealed. Options for method are: with an insulation-filled plastic bag, or a mastic-coated hog hair filter and placed at least 6 in. beyond the last register opening in order to retain balanced airflow. Gaps between the walls of the plenum and the blocking material must be sealed with mastic. mesh tape shall be used to seal gaps exceeding $\frac{1}{4}$ in.

The connection between the plenum and the furnace shall be sealed. This connection is typically located underneath the furnace. This connection can sometimes be accessed from interior space; if not it will be necessary to cut open the belly liner and access it from beneath the manufactured home. Photographic documentation is required if this measure cannot be performed.

Duct systems in manufactured homes do not require insulation that is separate from that of the belly insulation.

27200 Distribution System Repair and Replacement

Every effort shall be made to repair the existing distribution system components before replacement is considered. If register boots are damaged to the point where adequate air sealing is neither possible nor cost-effective, new boots may be constructed using aluminum coil stock or a comparable material. Prefabricated register boots may be purchased and installed if available.

The plenum may be repaired and/or patched for the purposes of air sealing ducts by using aluminum or steel sheets that are not less than 30 GA in thickness. The patch must be attached to the trunk line using stainless or galvanized screws 1 in. or less in length and sealed with duct mastic. All duct sealing and repairs done from beneath the manufactured home must be completed prior to insulating the manufactured home belly.

27210 Belly Return Conversions

Under no circumstances shall the belly of a manufactured home be used as a return plenum. If such a circumstance is discovered, a central return must be created by:

- A) Replacing the solid furnace door with a louvered door or retrofitting the existing door with an appropriately sized return grill. In either case, an appropriately sized filter grill must be supplied.
- B) Air sealing the belly return grilles in the floors of bedrooms, bathrooms, kitchen, living area, etc. and in the floor of the furnace closet, if one exists. Air sealed return grilles must be tested and readings must be 1.0 Pa or less.

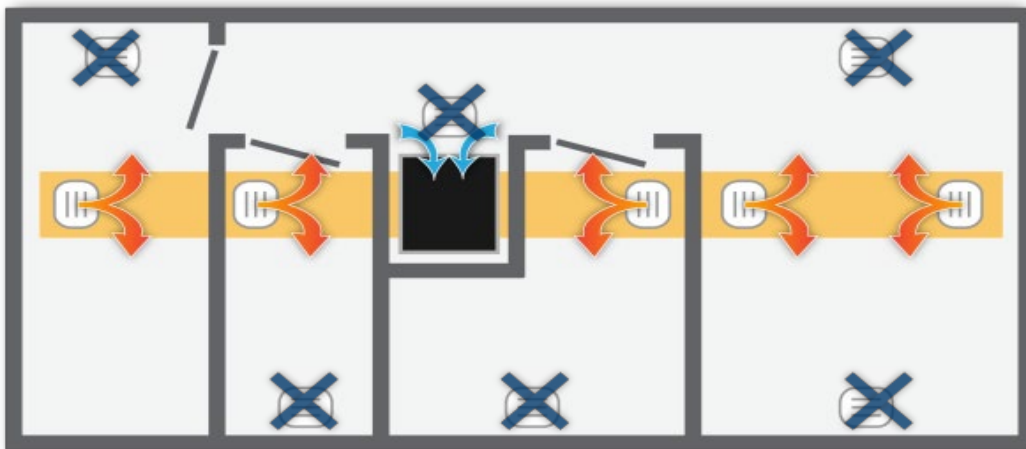

In manufactured homes with belly returns, room pressures may increase significantly once the system has been converted to a central hallway return system. Retest the room pressures after the belly return conversion and take the appropriate measures if the room pressures are greater than +/- 3 Pa WRT the inside of the mobile home.

27220 Crossover Ducts

Crossover ducts shall be inspected for integrity and repaired or replaced if any part of the insulation or inner liner is brittle or damaged. The duct must be replaced if the inner liner is composed of a mesh material. If replacement is required, either rigid metal ductwork or foil-wrapped flex duct with a minimum insulation R-value of R-8 shall be installed. Crossover duct runs, whether rigid or flexible, shall be as straight and short as possible and suspended off the ground.

28000 Air Sealing Measures

28100 Exterior Storm Windows

Exterior storm windows shall only be installed in manufactured homes over single pane, non-fixed windows. New storm windows must not be used to replace existing storms if the existing storm windows are in good condition. Metal exterior storm windows must meet with the following requirements:

- A) Storm windows shall be caulked around the frame at time of installation, except for weep holes that shall not be sealed;

- B) Storm-window sashes must be removable from indoors; and
- C) Fixed storm windows must not restrict the existing capacity and access required for emergency exits.

29000 Insulation Measures

Insulation in manufactured homes is typically inadequate to maintain either thermal comfort or energy efficiency. Due to structural limitations and manufacturing techniques, nearly all manufactured homes weatherized will require that additional insulation be added. Cellulose insulation is not approved for any insulation application in manufactured homes.

29100 Roof Cavity Insulation

Soffit-vented roof cavities shall be insulated according to Site-Built Installation Standards. Attic insulation installed in soffit-vented roof cavities must allow for attic ventilation to be maintained (the attic shall not be blown to capacity nor shall the soffit vents be filled with insulation. Unvented roof cavities in weatherized manufactured homes shall be insulated to capacity. Under no circumstances shall roof cavities be dense packed. Cellulose insulation is not a permissible material. In cases where an additional roof has been retrofitted over the original roof, only the original roof cavity shall be insulated.

Justification shall be required for any instance where roof cavity insulation could not be achieved, and such justification (including photographs) shall be maintained in the job file.

29110 Pre-Roof Cavity Insulation Inspection and Preparation

Roof cavities shall be inspected to determine the amount of existing insulation, if any, and to note any structural problems by drilling inspection holes in inconspicuous locations. Plastic plugs shall be used to repair the drill holes created during interior inspection. The client's written consent must be secured prior to drilling any inspection holes into the manufactured home. Exterior inspection holes are also permissible but may only be drilled if the auditor has the appropriate materials to either reseal the roof or patch the inspection hole.

The electrical wiring shall be inspected to confirm that wiring is not cracked, blistered, or deteriorated and that circuits show no evidence of overloading. The client shall be asked about any known existing electrical problems.

Metal roofs shall be cleaned of dirt, leaves, and loose roofing material.

29120 General Roof Cavity Insulation Guidelines

There are three typical types of manufactured home roofs: bowstring, flat, and peaked. Each type of roof has at least two acceptable methods for insulating. Polyvinyl Chloride (PVC) pipe creates static electricity and, therefore, shall not be used as an extension for the purposes of blown insulation. Rigid extension pipes of other materials, such as a painter's extension pole, may be attached to the side of the insulation hose.

In the case of sloped or vaulted ceilings, a combination of these methods may be needed and is allowed. Insulating from the interior of the manufactured home is not recommended but is allowable. Plastic plugs are available to repair the holes drilled in the ceiling if this method becomes necessary.

29121 Roof Cavity Fill Method

The following procedure is appropriate for metal unvented manufactured home roof types. Sloped or vaulted roofs may also be insulated using this method. This method shall not be used in vented roof cavities.

- A) Cut 10 in.² holes in the roof on one or both sides of the ridge vent, or peak of the roof, above every second truss. Each hole should be able to access two truss cavities simultaneously.
- B) Insert a fill hose that is 2-2 ¼ in. in diameter and tapered to a 45° angle into the access hole toward the edge of the roof cavity and insulate to capacity, moving the hose in all four horizontal directions. As the cavity is filled, the insulation should “push” the hose back toward the installer, indicating that the cavity is sufficiently insulated.
- C) Patch the roof using a 14 in.² stiff, galvanized steel patch screwed into the existing roof with hex-head screws set every 2 in. and place the silicone sealant so that it is squeezed between the roof and the patch. Then add more across the seam of the edge. It may be necessary to clean around the access holes to ensure proper adhesion.
- D) Cover the first galvanized steel patch with an 18 in.² patch consisting of foil-faced butyl rubber. In colder temperatures, it may be necessary to heat this patch around the edges to ensure proper adhesion.
- E) The entire roof shall be carefully inspected and all potential leak sites shall be patched and coated as needed to protect against moisture issues, such as wet insulation.

The following procedure is appropriate for shingled unvented manufactured home roof types.

- A) The shingles shall be removed with a flat bar and reused if possible. If new shingles must be purchased for replacement a similar type and color will be secured. The owner must authorize the use of similar shingles before weatherization work begins.
- B) Cut 10 in.² holes in roof on one or both sides of the ridge vent, or peak of the roof above every second truss. Each hole should be able to access two truss cavities simultaneously. If a ridge cap is present, it may be used for access instead of cutting access holes.
- C) Insert a fill hose that is 2-2 ¼ in.² in diameter and tapered to a 45° angle into the access hole toward the edge of the roof cavity and insulate to capacity, moving the hose in all four horizontal directions. As the cavity is filled, the insulation should “push” the hose back toward the installer, indicating that the cavity is being sufficiently insulated. Existing roof vents may be used in lieu of cutting new access holes to apply insulation; however, additional roof or vent caps shall not be added as an alternative to sealing roof patches after insulating.
- D) Cut holes shall be plugged with a material similar to the roof deck. The plug shall be sealed prior to reinstalling the shingles.

MOBILE HOME CEILING INSULATION BAG COUNT CHART

Installed Density: 25LB/BAG

Bag Weight: 1.6LB/CUBIC FT.

SQ FOOTAGE

TOTAL INCHES OF SPACE AT CENTER OF MOBILE CEILING

	<u>3</u>	<u>4</u>	<u>5</u>	<u>6</u>	<u>7</u>	<u>8</u>	<u>9</u>	<u>10</u>	<u>11</u>	<u>12</u>
400	2	3	4	5	6	7	8	9	10	11
450	2	3	5	6	7	8	9	11	12	13
475	2	3	5	6	7	9	10	11	12	14
500	2	4	5	6	8	9	10	12	13	14
525	2	4	5	7	8	9	11	12	14	15
550	3	4	6	7	8	10	11	13	14	16
575	3	4	6	7	9	10	12	13	15	16
600	3	4	6	8	9	11	12	14	16	17
625	3	5	6	8	10	11	13	15	16	18
650	3	5	7	8	10	12	13	15	17	19
675	3	5	7	9	10	12	14	16	18	19
700	3	5	7	9	11	13	14	16	18	20
725	3	5	7	9	11	13	15	17	19	21
750	4	6	8	10	12	14	16	18	20	22
775	4	6	8	10	12	14	16	18	20	22
800	4	6	8	10	12	14	17	19	21	23
825	4	6	8	10	13	15	17	19	21	24
850	4	6	9	11	13	15	18	20	22	24
875	4	6	9	11	13	16	18	20	23	25
900	4	7	9	11	14	16	19	21	23	26
925	4	7	9	12	14	17	19	22	24	27
950	4	7	10	12	15	17	20	22	25	27
975	5	7	10	12	15	18	20	23	25	28
1000	5	7	10	13	15	18	21	23	26	29
1025	5	8	10	13	16	18	21	24	27	29
1050	5	8	11	13	16	19	22	25	27	30
1075	5	8	11	14	16	19	22	25	28	31
1100	5	8	11	14	17	20	23	26	29	32
1125	5	8	11	14	17	20	23	26	29	32
1150	5	8	12	15	18	21	24	27	30	33
1175	5	9	12	15	18	21	24	27	31	34
1200	6	9	12	15	18	22	25	28	31	34

EXISTING INSULATION IN INCHES 2
 WIDTH OF MOBILE HOME IN FEET 12
 CEILING DEPTH AT OUTER EDGE IN INCHES 2
 EXISTING FIBERGLASS DENSITY IN LBS/FT3 0.9

TRUSS SIZE IN INCHES LENGTH 2
 WIDTH 2
 SPACING BETWEEN TRUSSES IN INCHES 16

THIS CHART SHOULD BE USED AS A GUIDELINE ONLY. THE ACTUAL NUMBER OF BAGS INSTALLED WILL VARY DEPENDING UPON THE SPECIFIC CONSTRUCTION OF EACH MOBILE HOME

29122 Side Lift Method

The following procedure is appropriate for metal unvented manufactured home roof types. Sloped or vaulted roofs may also be insulated using this method.

- A) Remove the J-channel guttering along the edge of the roofline along with any staples and putty tape.
- B) Pry up the roof enough to accommodate a 45° angled 10-14 ft. rigid hose extension. The roof can be propped open while insulating with a small section of pipe or lumber. Work in small 6-8 ft. sections.
- C) The extension should be inserted as close to center of roof cavity as possible and filled to capacity. As cavity is filled, insulation should “push” the hose back toward the installer, indicating that cavity is being sufficiently insulated. Ensure that the cavity is not overfilled.
- D) Reattach the lip of the roof and use self-tapping aluminum hex head screws and butyl putty tape to secure and seal the J-channel gutter.

29123 Gable End Method

The following procedure is appropriate for metal unvented manufactured home bowstring and peaked roof types. This method is best used in combination with other methods, as it may not be possible to insulate the entire length of the manufactured home from the ends.

- A) Remove the gable vents or the entire gable end siding.
- B) Attach a 45° angled 10-14 ft. rigid extension to the end of the insulation hose and insert it into the manufactured home roof cavity, taking care to insulate around and under any structural beams or obstructions and to fill it to capacity.
- C) Reinstall the gable end vents or siding.

29130 Cool Sealing

Cool roof coatings are an allowable measure as they can reduce cooling costs as well as providing additional moisture protection for the installed roof cavity insulation. The cool roof coating shall be an Energy Star®-qualified elastomeric material. Application should follow the manufacturer’s recommendation. Preparation for the cool sealing shall include the following:

- A) Sand any rusted areas down to sound metal. If the rusted areas are greater than 30% of the roof or if the rusted through areas are greater than 5%, the manufactured home must be deferred.
- B) Reinforce any open joints around skylights, pipe flashings, roof drains, and wall transitions with a mesh roof fabric and roof coating. Dip the fabric patches in the roof coating and spread them over the existing roof or lay dry fabric onto a layer of wet coating on the roof. Smooth the patch down with a broad knife or squeegee to remove any wrinkles or bubbles and allow at least 24 hours for curing before applying the coating.
- C) Protect windows, siding, and vehicles from splatters and overspray.

29200 Belly Insulation

The belly cavity shall be filled to capacity regardless of existing insulation value. Belly cavities shall be secured, with 1 in. by 1 in. furring strips, if necessary, to hang no lower than 24 inches below the subfloor and shall be blown to resistance, and not dense-packed. Installation of batt insulation is not allowable.

29210 Pre-Belly Insulation Inspection Preparations

Carefully inspect the interior of the manufactured home prior to insulating in order to prevent infiltration of belly insulation into the interior of the dwelling. Ensure that all appropriate air sealing and duct sealing has been performed. Secure all ducts and water piping to the floor where possible. Address any missing or deteriorated belly liner and belly board as follows:

- A) Holes in the belly liner up to 24 in. in diameter shall be patched using a self-adhesive belly patch (e.g. *Flexmend*) and shall be reinforced with stitch (or butterfly) staples.
- B) Holes in the belly liner that are 24 in. and larger in diameter shall be patched with replacement belly fabric and with stitch staples and shall be covered with adhesive belly repair material with a minimum overlap width of 4 in. Stitch staples alone are not adequate, as they can fail once the belly liner has been properly insulated to capacity.
- C) For a severely deteriorated belly liner, full replacement may be warranted. Replacement shall proceed as follows:
 - 1. remove the remains of the old liner.
 - 2. fasten the house wrap between the center I-beams with staples along the length of the home, ensuring that the liner is fitted securely around penetrations and appropriately sealed.
 - 3. reinforce with furring or lathe strips screwed into the bottom of the floor joists every 10-15 ft., or as the manufactured home condition warrants. This shall be done with care to avoid damaging the duct trunk line and water lines in the belly.

Rigid board insulation shall be used for patching or otherwise repairing the wings on either side of the manufactured home, but it is not recommended for the larger center section due to the larger area and lack of support beams.

MOBILE HOME BELLY INSULATION BAG COUNT CHART

BAG WEIGHT

25LB/BAG

SQ FOOTAGE

INSTALLED DENSITY

1.6LB/CUBIC FT.

AVERAGE INCHES OF SPACE IN MOBILE HOME BELLY

	<u>3.5</u>	<u>4</u>	<u>5</u>	<u>5.5</u>	<u>6</u>	<u>7</u>	<u>8</u>	<u>9</u>	<u>10</u>	<u>11</u>
400	3	4	6	7	8	10	13	15	17	19
425	3	4	7	8	9	11	13	16	18	20
450	3	5	7	8	9	12	14	17	19	21
475	4	5	7	9	10	12	15	17	20	23
500	4	5	8	9	10	13	16	18	21	24
525	4	5	8	10	11	14	17	19	22	25
550	4	6	8	10	11	14	17	20	23	26
575	4	6	9	10	12	15	18	21	24	27
600	4	6	9	11	12	16	19	22	25	28
625	5	6	10	11	13	16	20	23	26	30
650	5	7	10	12	13	17	20	24	27	31
675	5	7	10	12	14	18	21	25	28	32
700	5	7	11	13	15	18	22	26	29	33
725	5	7	11	13	15	19	23	27	30	34
750	6	8	12	14	16	20	24	28	32	36
775	6	8	12	14	16	20	24	28	33	37
800	6	8	12	14	17	21	25	29	34	38
825	6	8	13	15	17	21	26	30	35	39
850	6	9	13	15	18	22	27	31	36	40
875	6	9	13	16	18	23	27	32	37	41
900	7	9	14	16	19	23	28	33	38	43
925	7	9	14	17	19	24	29	34	39	44
950	7	10	15	17	20	25	30	35	40	45
975	7	10	15	18	20	25	31	36	41	46
1000	7	10	15	18	21	26	31	37	42	47
1025	8	10	16	18	21	27	32	38	43	49
1050	8	11	16	19	22	27	33	39	44	50
1075	8	11	16	19	22	28	34	39	45	51
1100	8	11	17	20	23	29	34	40	46	52
1125	8	11	17	20	23	29	35	41	47	53
1150	8	11	18	21	24	30	36	42	48	54
1175	9	12	18	21	24	31	37	43	49	56
1200	9	12	18	22	25	31	38	44	50	57

EXISTING INSULATION IN INCHES 2
 WIDTH OF MOBILE HOME IN FEET 12
 SIZE OF TRUNK LINE IN INCHES 2
 WIDTH: 12
 HEIGHT: 5

JOINT SIZE: LENGTH 1.75
 WIDTH: 5.5
 SPACING BETWEEN JOIST IN INCHES 16
 EXISTING FIBERGLASS DENSITY LBS/FT 0.9

THIS CHART SHOULD BE USED AS A GUIDELINE ONLY. THE ACTUAL NUMBER OF BAGS
 INSTALLED WILL VARY DEPENDING UPON THE SPECIFIC CONSTRUCTION OF EACH MOBILE HOME

29220 Belly Insulation Installation Requirements

- A) Cut holes in each outer rigger and in the center between the I-beams. Center the holes for the outer rigger between the outer rim joists.
- B) Insert a 45° angled 10-14 ft. rigid extended insulation hose and blow insulation to resistance.
- C) Patch holes as instructed in chapter 30210 A) of the Manufactured Home Installation Standards.

29230 Belly Insulation Protection

Replacement or installation of manufactured home skirting in order to protect weatherization measures from pests is not an allowable expense. The use of chicken wire around the perimeter is allowed for this purpose where no barrier exists, provided this measure does not constitute code violation in the applicable city or county.

29300 Sidewall Insulation

Sidewalls shall be insulated provided there is more than 1 in. of depth in a wall that has no insulation and an area equal to one long wall (excluding doors and windows) can be insulated. Due to the structural limitations of manufactured home walls, blown insulation shall not be allowed. Only high-density, unfaced, R-13 fiberglass batt insulation shall be installed.

29310 Pre-Sidewall Insulation Inspections & Preparation

Inspect all interior walls for holes and seal them prior to insulating. Weak or damaged walls shall be reinforced or repaired prior to insulating. Inspect walls to detect blocking which may impede sidewall insulation stuffing.

29320 Sidewall Insulation Guidelines

- A) Open the siding at the band joist by removing the fastening screws from the bottom of the wall panels. It may also be necessary to remove staples with a long pry bare from underneath the wall panels. If the manufactured home is partially insulated, pull out the existing insulation before installing new batts.
- B) Stuff the un-faced insulation into the cavity using a ¼ in. polycarbonate sheet or a galvanized stuffing tool of appropriate width and length to safely stuff the batt insulation into the cavity. Polycarbonate may be heated to create a 5° bend, 12 in. from one end, which can ease installation of the insulation past obstructions.
- C) Repeat Steps 1. and 2. for all wall cavities and refasten the siding.

30000 Base Load Reductions

30100 Water Heater Reduction Measures

Water heaters located in exterior closets shall have ZPDs taken to determine if the closet should be considered outside or inside the conditioned space. If it is determined to be outside, all wall surfaces between the closet and the inside shall be insulated and air sealed. If it is determined to be inside, only the exterior access door shall be

insulated. Fuel-fired water heaters located in manufactured homes must be sealed combustion.

31000 Windows and Doors

Refer to Site-built Sections 9250-9271

Appendix A to Part 440 - Standards for Weatherization Materials

Pt. 440, App. Appendix A to Part 440—Standards for Weatherization Materials. The following Government standards are produced by the Consumer Product Safety Commission and are published in title 16, Code of Federal Regulations:

Thermal Insulating Materials for Building Elements Including Walls, Floors, Ceilings, Attics, and Roofs Insulation—organic fiber—conformance to Interim Safety Standard in 16 CFR part 1209; Fire Safety Requirements for Thermal Insulating Materials According to Insulation Use—Attic Floor—insulation materials intended for exposed use in attic floors shall be capable of meeting the same flammability requirements given for cellulose insulation in 16 CFR part 1209; Enclosed spaces—insulation materials intended for use within enclosed stud or joist spaces shall be capable of meeting the smoldering combustion requirements in 16 CFR part 1209. The following standards which are not otherwise set forth in part 440 are incorporated by reference and made a part of part 440. The following standards have been approved for incorporation by reference by the Director of the Federal Register in accordance with 5 U.S.C. 552(a) and 1 CFR part 51. These materials are incorporated as they exist on April 5, 1993 and a notice of any change in these materials will be published in the **Federal Register**. The standards incorporated by reference are available for inspection at the National Archives and Records Administration (NARA). For information on the availability of this material at NARA, call 202-741-6030, or go to:

http://www.archives.gov/federal_register/code_of_federal_regulations/ibr_locations.html. The standards incorporated by reference in part 440 can be obtained from the following sources: Air Conditioning and Refrigeration Institute, 1501 Wilson Blvd., Arlington, VA 22209; (703) 524-8800. American Gas Association, 1515 Wilson Blvd., Arlington, VA 22209; (703) 841-8400. American National Standards Institute, Inc., 1430 Broadway, New York, NY 10018; (212) 642-4900. American Society of Mechanical Engineers, United Engineering Center, 345 East 47th Street, New York, NY 10017; (212) 705-7800. American Society for Testing and Materials, 1916 Race Street, Philadelphia, PA 19103; (215) 299-5400. American Architectural Manufacturers Association, 1540 East Dundee Road, Palatine, IL 60067; (708) 202-1350. Federal Specifications, General Services Administration, Specifications Section, Room 6654, 7th and D Streets, SW, Washington, DC 20407; (202) 708-5082. Gas Appliance Manufacturers Association, 1901 Moore St., Arlington, VA 22209; (703) 525-9565. National Electrical Manufacturers Association, 2101 L Street, NW, Suite 300, Washington, DC 20037; (202) 457-8400. National Fire Protection Association, Batterymarch Park, P.O. Box 9101, Quincy, MA 02269; (617) 770-3000. National Standards Association, 1200 Quince Orchard Blvd., Gaithersburg, MD 20878; (301) 590-2300. (NSA is a local contact for materials from ASTM). National Wood Window and Door Association, 1400 East Touhy Avenue, Des Plaines, IL 60018; (708) 299-5200. Sheet Metal and Air Conditioning Contractors Association, P.O. Box 221230, Chantilly, VA 22022-1230; (703) 803-2980. Steel Door Institute, 712 Lakewood Center North, 14600 Detroit Avenue, Cleveland, OH 44107; (216) 899-0100. Steel Window Institute, 1230 Keith Building, Cleveland, OH 44115; (216) 241-7333. Tubular Exchanger Manufacturers Association, 25 North Broadway, Tarrytown, NY 10591; (914) 332-0040.

Underwriters Laboratories, Inc., P.O. Box 75530, Chicago, IL 60675-5330; (708) 272-8800. More information regarding the standards in this reference can be obtained from the following sources: Environmental Protection Agency, 401 M Street, NW, Washington, DC 20006; (202) 554-1080. National Institute of Standards and Technology, U.S. Department of Commerce, Gaithersburg, MD 20899, (301) 975-2000. Weatherization Assistance Programs Division, Conservation and Renewable Energy, Mail Stop 5G-023, Forrestal Bldg., 1000 Independence Ave, SW, Washington, DC 20585; (202) 586-2207. Thermal Insulating Materials for Building Elements Including Walls, Floors, Ceilings, Attics, and Roofs

[Standards for conformance]

Insulation—mineral fiber:	
Blanket insulation	ASTM 1 C665-88.
Roof insulation board	ASTM C726-88.

Loose-fill insulation	ASTM C764-88.
Insulation—mineral cellular:	
Vermiculite loose-fill insulation	ASTM C516-80 (1990).
Perlite loose-fill insulation	ASTM C549-81 (1986).
Cellular glass insulation block	ASTM C552-88.
Perlite insulation board	ASTM C728-89a.
Insulation—organic fiber:	
Cellulosic fiber insulating board	ASTM C208-72 (1982).
Cellulose loose-fill insulation	ASTM C739-88.
Insulation-organic cellular:	
Preformed block-type polystyrene insulation	ASTM C578-87a.
Rigid preformed polyurethane insulation board	ASTM C591-85.
Polyurethane or polyisocyanurate insulation board faced with aluminum foil on both sides	FS 2 HH-I-1972/1 (1981).
Polyurethane or polyisocyanurate insulation board faced with felt on both sides	FS HH-I-1972/2 (1981). And Amendment 1, October 3, 1985.
Insulation—composite boards:	
Mineral fiber and rigid cellular polyurethane composite roof insulation board	ASTM C726-88.
Perlite board and rigid cellular polyurethane composite roof insulation	ASTM C984-83.

Gypsum board and polyurethane or polyisocyanurate composite board	FS HH-I-1972/4 (1981).
Materials used as a patch to reduce infiltration through the building envelope	Commercially available.

1 ASTM indicates American Society for Testing and Materials.

2 FS indicates Federal Specifications.

Thermal Insulating Materials for Pipes, Ducts, and Equipment Such as Boilers and Furnaces.....

[Standards for conformance]

Insulation—mineral fiber:	
Preformed pipe insulation	ASTM 1 C547-77.
Blanket and felt insulation (industrial type)	ASTM C553-70 (1977).
Blanket insulation and blanket type pipe insulation (metal-mesh covered) (industrial type)	ASTM C592-80.
Block and board insulation	ASTM C612-83.
Spray applied fibrous insulation for elevated temperature	ASTM C720-89.
High-temperature fiber blanket insulation	ASTM C892-89.
Duct work insulation	Selected and applied according to ASTM C971-82.
Insulation—mineral cellular:	
Diatomaceous earth block and pipe insulation	ASTM C517-71 (1979)
Calcium silicate block and pipe insulation	ASTM C533-85 (1990).
Cellular glass insulation	ASTM C552-88.

Expanded perlite block and pipe insulation	ASTM C610-85.
Insulation—Organic Cellular:	
Preformed flexible elastomeric cellular insulation in sheet and tubular form	ASTM C534-88.
Unfaced preformed rigid cellular polyurethane insulation	ASTM C591-85.
Insulation skirting	Commercially available.

1 ASTM indicates American Society for Testing and Materials.

Fire Safety Requirements for Insulating Materials According to Insulation Use.....

[Standards for conformance]

Attic floor	Insulation materials intended for exposed use in attic floors shall be capable of meeting the same smoldering combustion requirements given for cellulose insulation in ASTM 1 C739-88.
Enclosed space	Insulation materials intended for use within enclosed stud or joist spaces shall be capable of meeting the smoldering combustion requirements in ASTM C739-88.
Exposed interior walls and ceilings	Insulation materials, including those with combustible facings, which remain exposed and serve as wall or ceiling interior finish, shall have a flame spread classification not to exceed 150 (per ASTM E84-89a).
Exterior envelope walls and roofs	Exterior envelope walls and roofs containing thermal insulations shall meet applicable local government building code requirements for the complete wall or roof assembly.
Pipes, ducts, and equipment	Insulation materials intended for use on pipes, ducts and equipment shall be capable of meeting a flame spread classification not to exceed 150 (per ASTM E84-89a).

1 ASTM indicates American Society for Testing and Materials.

Storm Windows.....

[Standards for conformance]

Storm windows:	
----------------	--

Aluminum insulating storm windows	ANSI/AAMA 11002.10-83.
Aluminum frame storm windows	ANSI/AAMA 1002.10-83.
Wood frame storm windows	ANSI/NWWDA 2 I.S. 2-87. (Section 3)
Rigid vinyl frame storm windows	ASTM 3 D4099-89.
Frameless plastic glazing storm	Required minimum thickness windows is 6 mil (.006 inches).
Movable insulation systems for windows	Commercially available.

1 ANSI/AAMA indicates American National Standards Institute/American Architectural Manufacturers Association.

2 ANSI/NWWDA indicates American National Standards Institute/National Wood Window & Door Association.

3 ASTM indicates American Society for Testing and Materials.

Storm Doors.....

[Standards for conformance]

Storm doors—Aluminum:	
Storm Doors	ANSI/AAMA 1 1102.7-89.
Sliding glass storm doors	ANSI/AAMA 1002.10-83.
Wood storm doors	ANSI/NWWDA 2 I.S. 6-86.
Rigid vinyl storm doors	ASTM 3 D3678-88.
Vestibules:	
Materials to construct vestibules	Commercially available.

Replacement windows:	
Aluminum frame windows	ANSI/AAMA 101-88.
Steel frame windows	Steel Window Institute recommended specifications for steel windows, 1990.
Wood frame windows	ANSI/NWWDA I.S. 2-87.
Rigid vinyl frame windows	ASTM D4099-89.

1 ANSI/AAMA indicates American National Standards Institute/American Architectural Manufacturers Association.

2 ANSI/NWWDA indicates American National Standards Institute/National Wood Window & Door Association.

3 ASTM indicates American Society for Testing and Materials.

Replacement Doors

[Standards for conformance]

Replacement doors—Hinged doors:	
Steel doors	ANSI/SDI 1 100-1985.
Wood doors:	
Flush doors	ANSI/NWWDA 2 I.S. 1-87. (exterior door provisions)
Pine, fir, hemlock and spruce doors	ANSI/NWWDA I.S. 6-86.
Sliding patio doors:	
Aluminum doors	ANSI/AAMA 3 101-88.
Wood doors	NWWDA I.S. 3-83.

1 ANSI/SDI indicates American National Standards Institute/Steel Door Institute.

2 ANSI/NWDA indicates American National Standards Institute/National Wood Window & Door Association.

3 ANSI/AAMA indicates American National Standards Institute/American Architectural Manufacturers Association.

Caulks and sealants:

[Standards for conformance]

Caulks and sealants:	
Putty	FS 1 TT-P-00791B, October 16, 1969 and Amendment 2, March 23, 1971.
Glazing compounds for metal sash	ASTM 2 C669-75 (1989).
Oil and resin base caulks	ASTM C570-72 (1989).
Acrylic (solvent types) sealants	FS TT-S-00230C, February 2, 1970 and Amendment 2, October 9, 1970.
Butyl rubber sealants	FS TT-S-001657, October 8, 1970.
Chlorosulfonated polyethylene sealants	FS TT-S-00230C, February 2, 1970 and Amendment 2, October 9, 1970.
Latex sealing compounds	ASTM C834-76 (1986).
Elastomeric joint sealants (normally considered to include polysulfide, polyurethane, and silicone)	ASTM C920-87.
Preformed gaskets and sealing materials	ASTM C509-84.

1 FS indicates Federal Specifications.

2 ASTM indicates American Society for Testing and Materials.

[Standards for conformance]

Weather-stripping	Commercially available.
Vapor retarders	Selected according to the provisions cited in ASTM 1 C755-85 (1990). Permeance not greater than 1 perm when determined according to the desiccant method described in ASTM E96-90.
Items to improve attic ventilation	Commercially available.
Clock thermostats	NEMA 2 DC 3-1989.

1 ASTM indicates American Society for Testing and Materials.

2 NEMA indicates National Electrical Manufacturers Association.

Heat Exchangers

[Standards for conformance]

Heat exchangers, water-to-water and steam-to-water	ASME 1 Boiler and Pressure Vessel Code, 1992, Sections II, V, VIII, IX, and X, as applicable to pressure vessels. Standards of Tubular Exchanger Manufacturers Association, Seventh Edition, 1988.
Heat exchangers with gas-fired appliances 2	Conformance to AGA 3 Requirements for Heat Reclaimer Devices for Use with Gas-Fired Appliances No. 1-80, June 1, 1980. AGA Laboratories Certification Seal.
Heat pump water heating heat recovery systems	Electrical components to be listed by UL. 4

1 ASME indicates American Society of Mechanical Engineers.

2 The heat reclaimer is for installation in a section of the vent connector from appliances equipped with draft hoods or appliances equipped with powered burners or induced draft and not equipped with a draft hood.

3 AGA indicates American Gas Association.

4 UL indicates Underwriters Laboratories.

Boiler/Furnace Control Systems

[Standards for conformance]

Automatic set back thermostats	Listed by UL. 1 Conformance to NEMA 2 DC 3-1989.
Line voltage or low voltage room thermostats	NEMA DC 3-1989.
Automatic gas ignition systems	ANSI 3 Z21.21-1987 and Z21.21a-1989. AGA 4 Laboratories Certification Seal.
Energy management systems	Listed by UL.
Hydronic boiler controls	Listed by UL.
Other burner controls	Listed by UL.

1 UL indicates Underwriters Laboratories.

2 NEMA indicates National Electrical Manufacturers Association.

3 ANSI indicates American National Standards Institute.

4 AGA indicates American Gas Association.

Water Heater Modifications

[Standards for conformance]

Insulate tank and distribution piping	(See insulation section of this appendix).
Install heat traps on inlet and outlet piping	Applicable local plumbing code.
Install/replace water heater heating elements	Listed by UL. 1
Electric, freeze-prevention tape for pipes	Listed by UL.
Reduce thermostat settings	State or local recommendations.

Install stack damper, gas-fueled	ANSI 2 Z21.66-1988, including Exhibits A&B, and ANSI Z223.1-1988.
Install stack damper, oil-fueled	UL 17, November 28, 1988, and NFPA 3 31-1987.
Install water flow modifiers	Commercially available.

1 UL indicates Underwriters Laboratories.

2 ANSI indicates American National Standards Institute.

3 NFPA indicates National Fire Prevention Association.

Waste Heat Recovery Devices

[Standards for conformance]

Desuperheater/water heaters	ARI 1 470-1987.
Condensing heat exchangers	Commercially available components and in new heating furnace systems to manufacturers' specifications.
Condensing heat exchangers	Commercially available (Commercial, multi-story building, with Teflon-lined tubes institutional) to manufacturers' specifications.
Energy recovery equipment	Energy Recovery Equipment and Systems Air-to-Air (1978) Sheet Metal and Air-Conditioning Contractors National Association (SMACNA). 2

1 ARI indicates Air Conditioning and Refrigeration Institute.

2 SMACNA denotes Sheet Metal and Air Conditioning Contractors' National Association.

Boiler Repair and Modifications/Efficiency Improvements

[Standards for conformance]

Install gas conversion burners	ANSI 1 Z21.8-1984, (for gas or oil-fired systems) ANSI Z21.17-1984, ANSI Z21.17a-1990, and ANSI Z223.1-1988. AGA 2 Laboratories Certification seal.
Replace oil burner	UL 3 296, February 28, 1989, Revision and NFPA 4 31-1987.

Install burners (oil/gas)	ANSI Z223.1-1988 for gas equipment and NFPA 31-1987 for oil equipment.
Re-adjust boiler water temperature or install automatic boiler temperature reset control	ASME 5 CSD-1-1988, ASME CSD-1a-1989, ANSI Z223.1-1988, and NFPA 31-1987.
Replace/modify boilers	ASME Boiler and Pressure Vessel Code, 1992, Sections II, IV, V, VI, VIII, IX, and X. Boilers must be Institute of Boilers and Radiation Manufacturers (IBR) equipment.
Clean heat exchanger, adjust burner air shutter(s), check smoke no. on oil-fueled equipment. Check operation of pump(s) and replacement filters	Per manufacturers' instructions.
Repair combustion chambers	Refractory linings may be required for conversions.
Replace heat exchangers, tubes	Protection from flame contact with conversion burners by refractory shield.
Install/replace thermostatic radiator valves	Commercially available. One pipe steam systems require air vents on each radiator; see manufacturers' requirements.
Install boiler duty cycle control system	Commercially available. NFPA 70, National Electrical Code (NEC) 1993 and local electrical codes provisions for wiring.

1 ANSI indicates American National Standards Institute.

2 AGA indicates American Gas Association.

3 UL indicates Underwriters Laboratories.

4 NFPA indicates National Fire Prevention Association.

5 ANSI/ASME indicates American National Standards Institute/American Society of Mechanical Engineers.

Heating and Cooling System Repairs and Tune-ups/Efficiency Improvements

[Standards for conformance]

Install duct insulation	FS 1 HH-I-558C, January 7, 1992 (see insulation sections of this appendix).
Reduce input of burner; derate gas-fueled equipment	Local utility company and procedures if applicable for gas-fueled furnaces and ANSI Z223.1-1988 (NFPA 354-1988) including Appendix H.
Repair/replace oil-fired equipment	NFPA 31-1987.
Replace combustion chamber in oil-fired furnaces or boilers	NFPA 31-1987.
Clean heat exchanger and adjust burner: adjust air shutter and check CO ₂ and stack temperature. Clean or replace air filter on forced air furnace	ANSI Z223.1-1988 (NFPA 54-1988) including Appendix H.
Install vent dampers for gas-fueled heating systems	Applicable sections of ANSI Z223.1-1988 (NFPA 54-1988) including Appendices H, I, J, and K. ANSI Z21.66-1988 and Exhibits A & B for electrically operated dampers.
Install vent dampers for oil-fueled heating systems	Applicable sections of NFPA 31-1987 for installation and in conformance with UL 417, November 28, 1988.
Reduce excess combustion air:	
A: Reduce vent connector size of gas-fueled appliances	ANSI Z223.1-1988 (NFPA 54-1988) Part 9 and Appendices G & H.
B: Adjust barometric draft regulator for oil fuels	NFPA 31-1987 and per manufacturers' (furnace or boiler) instructions.
Replace constant burning pilot with electric ignition device on gas-fueled furnaces or boilers	ANSI Z21.71-1981, Z21.71a-1985, and Z21.71b-1989.
Readjust fan switch on forced air gas or oil-fueled furnaces	Applicable sections and Appendix H of ANSI Z223.1-1988 (NFPA 54-1988) for gas furnaces and NFPA 31-1987 for oil furnaces.
Replace burners	See power burners (oil/gas).
Install/replace duct furnaces (gas)	ANSI Z223.1-1988 (NFPA 54-1988).

Install/replace heat pumps	Listed by UL.
Replace air diffusers, intakes, registers, and grilles	Commercially available.
Install/replace warm air heating metal ducts	Commercially available.
Filter alarm units	Commercially available.

1 FS indicates Federal Specifications.

2 ANSI indicates American National Standards Institute.

3 NFPA indicates National Fire Prevention Association.

4 UL indicates Underwriters Laboratories.

Replacement Furnaces, Boilers, and Wood Stoves.....

[Standards for conformance]

Chimneys, fireplaces, vents and solid fuel burning appliances	NFPA 1 211-1988.
Gas-fired furnaces	ANSI 2 Z21.47-1987, Z21.47a-1988, and Z21.47b-1989. ANSI Z223.1-1988 (NFPA 54-1988).
Oil-fired furnaces	UL 3 727, August 27, 1991 Revision and NFPA 31-1987.
Liquified petroleum gas storage	NFPA 58-1989.
Ventilation fans:	
Including electric attic, ceiling, and whole house fans	UL 507, August 23, 1990, Revision.

1 NFPA indicates National Fire Prevention Association.

2 ANSI indicates American National Standards Institute.

3 UL indicates Underwriters Laboratories.

Air Conditioners and Cooling Equipment.....

[Standards for conformance]

Air conditioners:	
Central air conditioners	ARI 1 210/240-1989.
Room size units	ANSI/AHAM 2 RAC-1-1982.
Other cooling equipment:	
Including evaporative coolers, heat pumps and other equipment	UL 3 1995, November 30, 1990. 4

1 ARI indicates Air Conditioning and Refrigeration Institute.

2 AHAM/ANSI indicates American Home Appliance Manufacturers/American National Standards Institute.

3 UL indicates Underwriters Laboratories.

4 This standard is a general standard covering many different types of heating and cooling equipment.

Screens, Window Films, and Reflective Materials.....

[Standards for conformance]

Insect screens	Commercially available.
Window films	Commercially available.
Shade screens:	

Fiberglass shade screens	Commercially available.
Polyester shade screens	Commercially available.
Rigid awnings:	
Wood rigid awnings	Commercially available.
Metal rigid awnings	Commercially available.
Louver systems:	
Wood louver systems	Commercially available.
Metal louver systems	Commercially available.
Industrial-grade white paint used as a heat-reflective measure on awnings, window louvers, doors, and exterior duct work (exposed)	Commercially available.

[58 FR 12529, Mar. 4, 1993, as amended at 69 FR 18803, Apr. 9, 2004]